

---

NuScope Associates

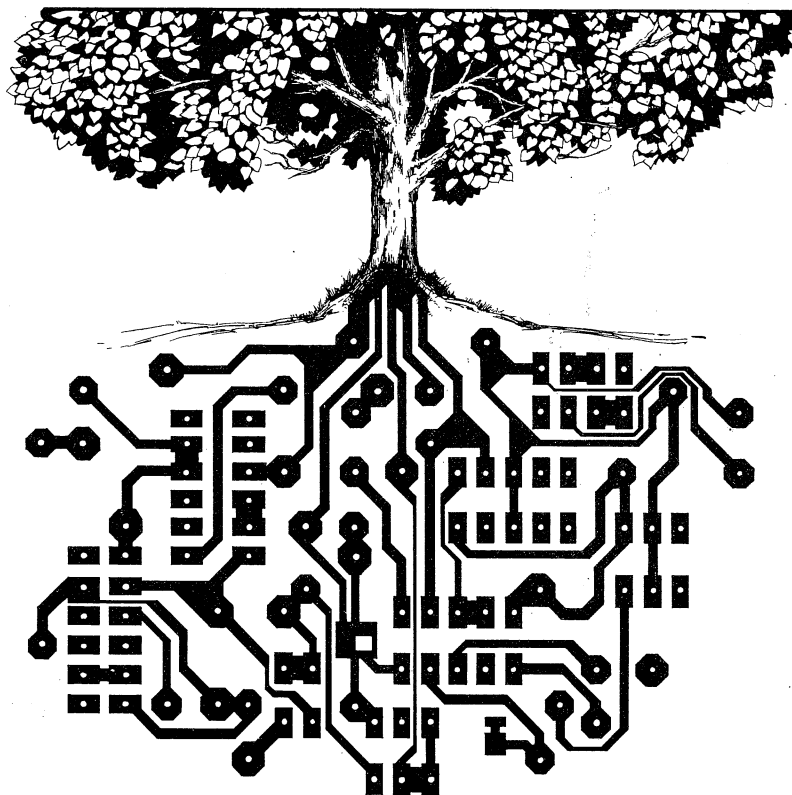

# Big Blue Seed



**THE AUTHORITATIVE GUIDE  
FOR ASSEMBLING IBM™ COMPATIBLE MOTHERBOARDS  
AND PERIPHERAL CIRCUIT CARDS  
WITH PARTS LIST AND COMPONENT LAYOUT**

**BY  
RAYMOND KOSMIC**

---

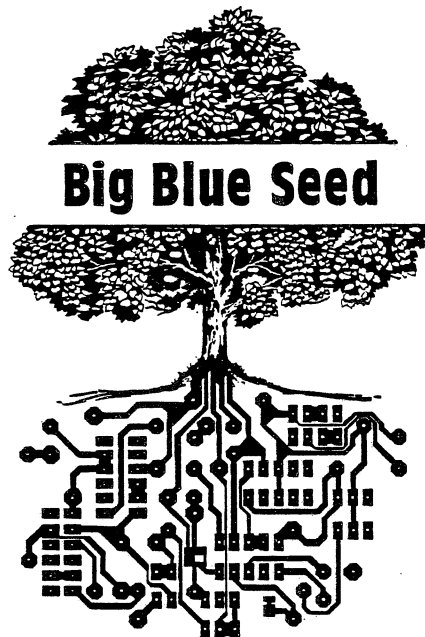

Other Computer Assembly Manuals by Raymond Kosmic

APPLE-SEED I: Motherboard Assembly Manual

APPLE-SEED II: Peripheral Circuit Card Assembly Manual

SURF-BOARD: Guide for Assembling the 6502 Surf-Board

Copyright © 1984

**NuScope Associates**

P.O. BOX 742, STN. B. WILLOWDALE, ONTARIO M2K 2R1 •

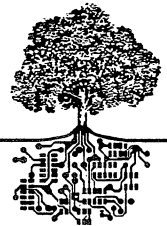

#### IMPORTANT NOTICE

All rights are reserved. No part of this manual may be reprinted, or reproduced, or transmitted in any form, including photocopy, without the prior consent of the publisher.

The information presented in this manual has been carefully reviewed and is believed to be entirely correct and reliable. However, the author and publisher assume no responsibility for errors and/or omissions, or for the success or failure of the different applications to which the information presented in this manual may be applied. Neither is any liability assumed for any infringement of patents or other rights of third parties that would result.

Apple is a registered trademark of Apple Computer Inc.

IBM PC and XT are registered trademarks of International Business Machines.

To

Natalie, John, and Andrea

## PREFACE

This reference manual was prepared as an aid for those who wish to assemble IBM compatible motherboards and peripheral circuit cards for their own personal use. The guides presented here were originally prepared for various suppliers and distributed along with each card or kit as a parts list with condensed assembly instructions. The suppliers have kindly allowed us to compile these guides together into one reference manual.

Each one of the guides is complete in itself and is independent from the other guides. All have been checked for accuracy by the suppliers and are thought to be correct. However, with approximately six thousand components to be identified and correctly positioned on over thirty boards, errors and/or omissions may occur. In no event will the suppliers or NuScope Associates be liable for damage resulting from the use of the information presented in this manual.

If you lack experience in electronics, you may wish to refer to the "Apple-Seed I: Motherboard Assembly Manual". This self-directing guide was designed and written for the first-time hobbyist in mind, as an educational reference for the construction and assembly of electronic devices that use printed circuit boards, integrated circuits, and electronic components.

It is planned to update this reference manual as other circuit boards come to our attention. Any suggestions for improvement would be greatly appreciated.

## ACKNOWLEDGEMENTS

I wish to express my appreciation to Tom Bell, Bramalea; Jerry Senczuk, East York; and Andy Szego, Willowdale. Their valuable assistance and technical advice were instrumental in the completion of this manuscript.

ACKNOWLEDGEMENTS (continued)

I also wish to thank the following suppliers for their encouragement and support and for checking the accuracy of the motherboard and peripheral card guides as follows:

Pete Brown and Fred Kohn of Active Surplus Annex, 345 Queen St W, Toronto, Ont, M5V 2A4:

XT-4, EKBM XT System Motherboard; 2-5, EK Disk Controller; 6-1, EK EPROM Burner and Asynch Serial; 6-3, EM-300 Modem

Bill Jackson of Computer Parts Galore Inc., 316 College St, Toronto, Ont, M5T 1S3:

XT-2, MBE-XT Motherboard; XT-3, MEGA-Board Motherboard; 2-3, PG Disk Controller; 3-4, 512 K RAM; 4-1, Colour Graphics Display; 4-4, PG-2 Monochrome Graphics; 5-1, Multifunction; 7-2, Memory Prototype; 7-3, Protoplus Prototype; 7-4, Extender

Nirmal Khamba of Electronic Control Systems, 1590 Matheson Rd, Suites 1 & 2, Mississauga, Ont, L4W 1J1:

PC-3, ECS Motherboard; XT-7, ECS-7 Grande Motherboard; 2-3, Floppy Disk Adapter; 2-6, ECS-4 Disk Controller; 7-1, Datamax-001

Min-Tsong Chang of Fountain Enterprises, 519 8th Ave, New York, NY, 10018:

XT-6, Super XT Motherboard; 3-3, Explorer Memory/Serial; 4-2, Fountain Monochrome Graphics; 4-3, Colour Graphics Adapter

Bob Kamins of HAL Computer Company, 296 Brunswick Ave, Toronto, Ont, M5S 2M7:

PC-2, HAL Computer Motherboard; 2-4, HAL Drive Parallel/Port; 3-2, HAL Memory/Serial

Joe Sutherland of JLS Research Inc., 94 Beverley St, Toronto, Ont M5T 1X7:

1-1, JLS OBM-100 Motherboard; 3-3, JLS OBM-1 Memory/Serial

Marcello Rocca of Robin Hood Electronics Inc., 20 Strathearn Ave, Brampton, Ont, L6T 4P7:

XT-1, Robin Hood XT Motherboard; XT-5, Prestige I Motherboard; XT-8, Prestige II Motherboard; 2-1, RHE Disk Controller

## TABLE OF CONTENTS

<b>PART I</b>	<b>GUIDELINES TO SUCCESS .....</b>	<b>1</b>
	Safety .....	1
	Using this Guide .....	1
	Guide to Components .....	4
	Card Installation and Removal .....	9
	Card and Connector Pinouts .....	11
	System Unit Hardware .....	12
	Appendix - Abbreviations .....	15

**PART II MOTHERBOARD AND PERIPHERAL CARD ASSEMBLY GUIDES .. 17**

SECTION	GUIDES	BOARDS AND CARDS
1 Motherboards	PC-1	JLS OBM-100
	PC-2	HAL Computer
	PC-3	ECS
	XT-1	Robin Hood XT
	XT-2	MBE-XT
	XT-3	MEGA-Board
	XT-4	EKBM XT System
	XT-5	Prestige I XT
	XT-6	Super XT
2 Disk Controller	2-1	RHE
	2-3	PG
	2-3	Floppy Disk Adapter
	2-4	HAL Drive/Parallel Port
	2-5	EK
	2-6	ECS-4
3 Memory	3-3	JLS OBM-1 Memory/Serial
	3-2	HAL Memory/Serial
	3-3	Explorer Memory/Serial
	3-4	512 K RAM
4 Video	4-1	Colour Graphics Display
	4-2	Fountain Monochrome Graphics
	4-3	Colour/Graphics Adapter
	4-4	PG-2 Monochrome Graphics
5 Multifunction	5-1	Multifunction
	5-2	Super Disk I/O
	5-3	Monte Carlo
6 Miscellaneous	6-1	EK EPROM Burner & Asynch
	6-2	Parallel Printer
	6-3	EM-300 Modem
7 Prototyping	7-1	Datamax-001
	7-2	Memory Prototype
	7-3	Protoplus Prototype
	7-4	Extender

**MOTHERBOARD  
FEATURES**

MOTHERBOARDS	GUIDE	on-board memory (K)	# of I/O slots	slot spacing	# of ROM sockets	documentation avail	schematics avail	length (mm)	width (mm)
JLS OBM-100	PC-1	0	5	PC	6	N	Y	291	257
HAL	PC-2	0	5	PC	6	Y	Y	294	263
ECS	PC-3	0	5	PC	6	N	N	293	260
ROBIN HOOD XT	XT-1	256	8	XT	8	Y	Y	303	216
MBE-XT	XT-2	256	8	XT	8	Y	Y	303	215
MEGA-Board	XT-3	256-1M	7+1	XT	5	Y	Y	343	266
EKBM XT System	XT-4	256	8	PC	8	Y	N	303	216
Prestige I XT	XT-5	256	8	PC	8	Y	Y	303	216
Super XT	XT-6	256	7	XT	8	N	N	303	216
ECS-7 Grande	XT-7	256-1M	7+1	XT	5	N	N	344	268
Prestige II XT	XT-8	256	8	XT	8	Y	Y	303	216

*uf - 5 way register*

\*

\*

PERIPHERAL CARD  
FEATURES

CARD		GUIDE										
		documentation avail	schematics avail	software req'd	length (mm)	width (mm)	disk controller*1	memory (k)	# of serial ports	# of parallel ports	# of game ports	other
DISK	RHE	Y	Y	Y	242	108	5 1/4 & 8					
	PG				238	106	5 1/4					
	Floppy Disk Adapter				174	109	5 1/4					
	HAL Drive/Parallel	Y			258	109	5 1/4		1			
	EK				237	106	5 1/4					
	ECS-4				148	108	5 1/4					
MEMORY	JLS OBM-1 Memory/Serial	Y	Y		329	113		256	1			
	HAL Memory/Serial		Y		328	117		256	1			
	Explorer Memory/Serial				337	119		256	1			
	512 K RAM				334	108		512				
VIDEO	Colour Graphics Display		Y		335	104						
	Fountain Monochrome Graphics	Y	Y		333	117						
	Colour Graphics Adapter	Y	Y		338	115						
	PG-2 Monochrome		Y		335	118						
MULTI	Multifunction	Y	Y	Y	333	115		256	1	1	1	
	Super Disk I/O	Y	Y		299	117	5 1/4		1	1		
	Monte Carlo	Y	Y	Y	335	118		256	1	1	2	
MISC	EK EPROM Burner & Serial*2	Y		Y	116	106			1			burner
	Parallel		Y		109	106						
	EM-300 Modem	Y		Y	138	104						300 baud
PROTO	Datamax-001				336	111						
	Memory Prototype				334	109						
	Protoplus Prototype				331	109						
	Extender				93	152						

\*1 5 1/4" and/or 8" drives. \*2 2-card set, external card is 99x67 mm.

(U) Prototype 1/2

## PART 1

### GUIDELINES TO SUCCESS

#### SAFETY

When cutting excessive wire leads from resistors, diodes, etc., protect your eyes. Wear safety glasses and keep the card at a reasonably safe distance. Turn your head to the side when trimming component leads.

Treat the soldering iron with respect. A hot iron can inflict a nasty burn. Do not touch the soldered connections before they have cooled down. Always rest the hot iron on a soldering stand when not in use. Turn the soldering iron off when you leave your work area.

Work in a well-ventilated area.

Observe all electrical and fire safety precautions.

There's less chance of an accident if your work area is clean and well organized.

#### USING THIS GUIDE

Examine the various assembly guides presented in this manual and select the motherboards or peripheral cards that you wish to build. Study the printed circuit board (PCB) in detail before mounting any components. Handle the board ONLY by its edges, NEVER by its surface. Fingerprints may leave a fine film of oil on the solder pads and prevent the solder from making a solid joint. If necessary, clean both sides of the boards with a special commercial cleaner or denatured alcohol (methyl alcohol) before soldering.

Visually inspect the PCB for breaks, shorts, etch-flaws, and irregularities in the lands (tracks). Illuminate the board from the solder side with a strong light. Examine the tracks for shorts and hair-line fractures. Pay special attention to the component side where the tracks will be covered over with sockets. You won't get a second chance to inspect these areas once hidden with components. Check the inner surface of the plate-thru holes; a shiny appearance indicates that they are, in fact, plated-thru. On the other hand, a dull appearance suggests a poorly-made circuit board. If flaws exist, either make the necessary repairs or return the board to the dealer.

Compare the silk-screening on the bare board to the silk-screening on the layout in the text. Record all differences. Check the parts list for availability and price. Mentally position each socket and electrical component and device in place before beginning the actual assembly.

Orientate the board so that the component side faces you. The gold-plated fingers of the peripheral cards should be at the lower right-hand corner.

**ALL COMPONENTS ARE MOUNTED ON THE COMPONENT SIDE  
AND SOLDERED TO THE SOLDER SIDE**

Study the precautions thoroughly (marked with an asterisk \* in the guides) before you begin to assemble a circuit board.

Each one of the guides is complete and independent of the others in this manual.

Use the guide as a shopping list. Refer to Fig. 1, A Portion of an Assembly Guide. Check off each component purchased in the space provided on the guide. Circle the appropriate component placement number after it has been installed. Some PCBs have the silk-screened labels printed directly under socket placements making it impossible to know which integrated circuit (IC) to install. If necessary, refer to the component placement layout for IC positioning.

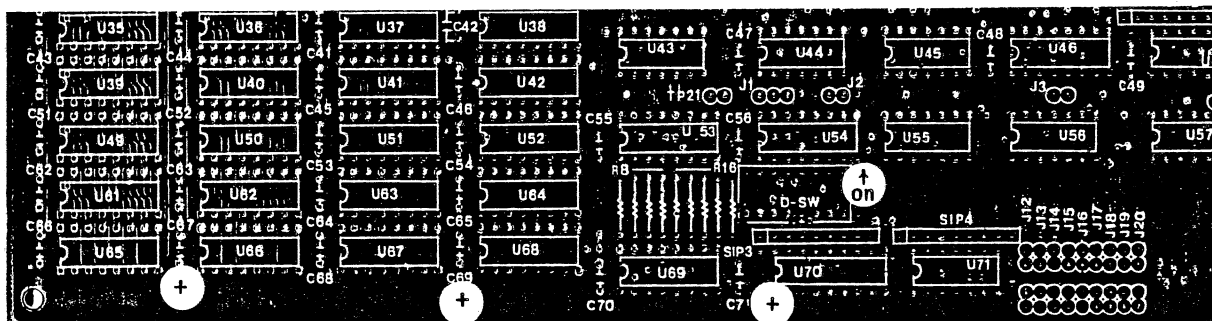

Layout is reduced. Actual size

**SUGGESTED SEQUENCE \*INDICATES A PRECAUTION**

**DIODES** \*Position banded end (cathode) of diodes as shown

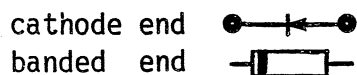

2 - IN4148

**RESISTORS** R 1/2 watt, 5%

- 9 - 22 Ω @ R8,9,10,11,12,13,14,
- 1 - 100 Ω @ R17 15,16
- 1 - 220 Ω @ R3
- 1 - 680 Ω @ R5
- 1 - 1.5 KΩ @ R7
- 1 - 2.2 KΩ @ R2

**RESISTORS (cont)**

- 1 - 1 MΩ @ R6
- 4 - 4.7 KΩ 9-pin SIP\* @ SIP 1,2,3,4
- \*Match pin 1 of SIPs with pin 1 (square pad) on the layout

**SOCKETS** \*Match pin 1 of sockets with pin 1 (square solder pad) on the layout. Check that ALL pins have passed thru ALL holes

- 19 - 14-pin
- 42 - 16-pin
- 1 - 18-pin

FIG. 1. A PORTION OF AN ASSEMBLY GUIDE.

The correct sequence of installing components is debatable. Try to keep all the components flush against the board. As a general rule, mount the components that are shortest in height first (diodes, resistors, sockets), followed by the taller components (capacitors, switches, resistor networks, etc.). This helps to keep the components tight against the board when soldering.

It may be more convenient, in some situations, to install sockets first. This may eliminate some confusion as to the placement of the smaller components, especially if the card is inadequately silk-screened or cluttered.

Component leads are NEVER inserted into FEED-THRU holes. On some of the boards illustrated, the FEED-THRU holes are smaller and can thus be distinguished from the larger COMPONENT holes.

The spacing between two solder holes on any one circuit board is often the same for each type of component. Thus resistor leads are bent to the same length. By-pass capacitors (0.1 uF) have a smaller hole-to-hole spacing. This may help you to decide the mounting position of some of the components.

Use a low-wattage (less than 35 watts) soldering iron with a small pencil, pyramid, or screw-driver tip. Use only rosin-core, radio-type solder with a 60/40 or 63/37 tin/lead content. NEVER use acid-core solder! NEVER use a solder gun!

Take care with your soldering. The soldering iron TIP should make firm contact with the PIN or component lead and the solder PAD as illustrated in FIG. 2. Apply solder to the opposite side of the pin touching both the pin and the pad. Follow this sequence:

IRON ON - SOLDER ON - SOLDER OFF - IRON OFF

Excessive heat may damage delicate components. If done correctly, soldering one pin or component lead should take no more than four to five seconds. More heat may be required on multi-layered boards such as the Colour Graphics Adapter Card, GUIDE 4-3.

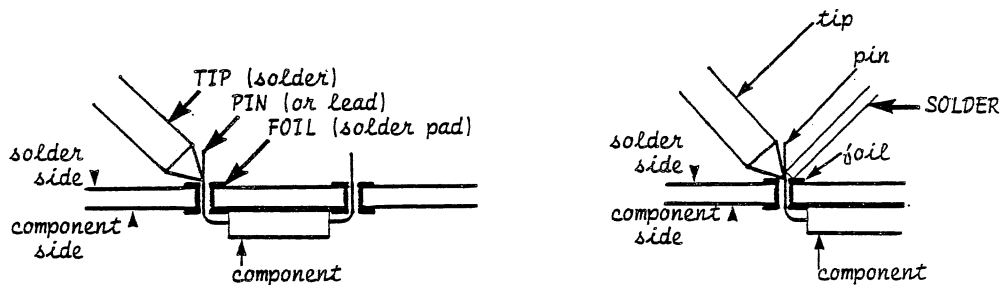

A. Three-Point Contact

B. Applying the Solder

FIG. 2. SOLDERING TECHNIQUES.

Some boards are "chip-sensitive" and appear to have a preference for devices made by a specific manufacturer. The parts list shows this source in brackets following the device. Other devices that are followed by a manufacturer's name in brackets are made only by that manufacturer.

Some boards require modifications as illustrated in GUIDE PC-1, JLS OBM-100 Motherboard. Modifications are done on the solder side except where indicated. Study the details thoroughly before attempting any modifications.

## GUIDE TO COMPONENTS

For a more detailed look at component identification and placement, and for installation techniques, refer to the "Apple-Seed: Motherboard Assembly Manual, an Introductory Guide," by the same author.

### DIODES AND LIGHT EMITTING DIODES (D)

Diodes are delicate and can be easily damaged by rough handling and excess heat. These devices are polarized and must be correctly oriented on the circuit board. Position the banded (cathode) end of the diode towards the tip of the arrow as shown in the following figure.

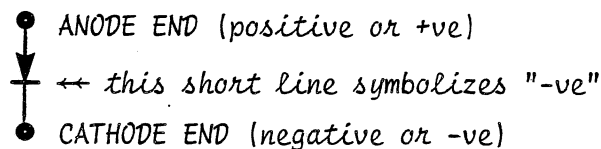

FIG. 3. IDENTIFYING THE CATHODE ON THE LAYOUT.

The polarity of light emitting diodes (LEDs) may be identified in one of the following ways:

- ve: a small "dot" on the body of the device
- ve: base of the device is "flat"
- +ve: the "longer" terminal or lead

### INDUCTORS (L)

The numerical value of inductors (coils) may be colour-coded on the body of the device. This value, in microhenries (uH), can be determined using Table 1 Resistor Colour Code Chart.

## RESISTORS (R)

The resistors used to assemble the majority of boards and cards illustrated in this manual are 1/4 watt, with a tolerance of 5 percent (%). Refer to the following table, Resistor Colour Code Chart, to determine the ohms value of resistors.

Table I. Resistor Colour Code Chart.

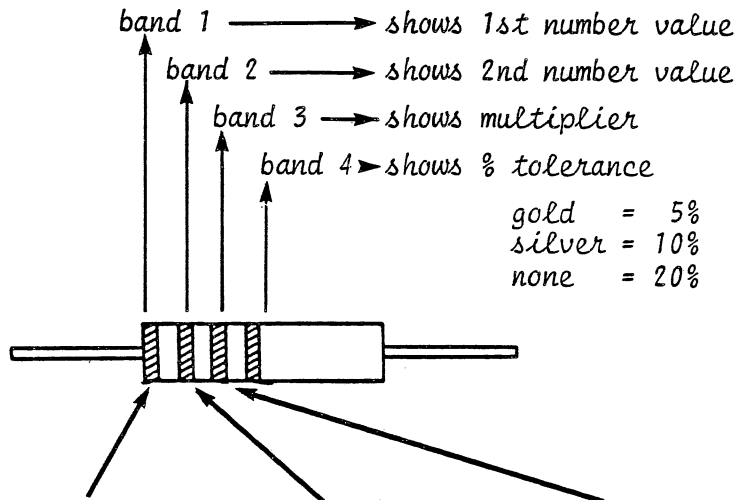

colour	1st digit	2nd digit	multiplier
black	0	0	1
brown	1	1	10
red	2	2	100
orange	3	3	1,000
yellow	4	4	10,000
green	5	5	100,000
blue	6	6	1,000,000
violet	7	7	10,000,000
gray	8	8	100,000,000
white	9	9	1,000,000,000
gold	-	-	0.1
silver	-	-	0.01

Examples: a) yellow - violet - black refers to

$$4 \quad 7 \quad \times 1 = 47 \Omega \text{ resistor}$$

b) brown - green - red refers to

$$1 \quad 5 \quad \times 100 = 1,500 \Omega \text{ or } 1.5 \text{ k}\Omega \text{ resistor}$$

a) SINGLE-IN-LINE PACKAGE (SIP) RESISTOR NETWORKS (RN) - BUSSED

The majority of SIP RNs used in this manual are bussed. Pin 1 of SIPs is common and must be correctly positioned in the circuit. Pin 1 of the device may be identified by a "dot", a "bar", or a number.

A bussed SIP resistor with the correct number of pins may not always be available. Purchase one with more pins than required and cut off the extra number of pins as close to the body of the device as possible. Do NOT REMOVE pin number 1. Do NOT allow the cut portion of the pins remaining on the device to touch the circuit card as they may cause a short circuit.

b) SINGLE-IN-LINE PACKAGE RESISTOR NETWORKS (RN) - BUSSED

Other boards described in this manual require isolated SIP resistors as shown in GUIDE 3-4, 512 K RAM Card. If isolated SIPs are not available, substitute the same number of single resistors of the same value. Stand the resistor on its end as shown in Fig. 4. Leave a small gap between the end of the resistor and the circuit card to prevent "solder wicking", i.e., solder creeping along the card and possibly causing a short circuit.

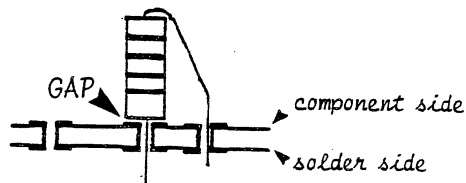

FIG. 4. INSTALLING A RESISTOR ON ITS END.

c) DUAL-IN-LINE PACKAGE (DIP) RESISTOR NETWORKS

Some boards require DIP resistor networks. These should be soldered to the board. If DIP resistors are not available, substitute the appropriate number of single resistors of the same value. Solder these flat against the board or stand them upright depending on the resistance configuration (isolated or bussed).

SOCKETS

It is strongly recommended that ALL integrated circuits be socketed. One of the best forms of trouble-shooting is "chip-swapping". Use high-quality dual-in-line package (DIP) solder-tail IC sockets.

CHECK AND RECHECK THAT

- pin 1 of each socket is properly oriented on the card
- each socket is installed in the correct position, i.e., a 14-pin socket is not mounted in a 16-pin opening
- ALL socket pins have passed thru ALL holes, i.e., no folded-under or folded-out pins
- each socket is flat against the card.

Do NOT attempt to remove a socket if it has been installed with pin 1 positioned incorrectly, i.e., socket turned thru 180°. Instead, apply a very small dab of typewriter correction fluid to the corner of the socket to mark and identify pin number 1.

CAPACITORS (C)

Capacitors are either electrolytic (polarized) or non-electrolytic (non-polarized). Polarized capacitors must be connected in the circuit so that their positive and negative terminals are correctly positioned in the circuit. Match the +ve terminal of these capacitors with the +ve end as shown on the layout. Non-polarized capacitors have neither +ve nor -ve ends and may be positioned in the circuit in any manner. Capacitors of values greater than 0.1 uF are generally polar. Refer to Table II to determine the value and tolerance of capacitors.

Table II. Multiplier and Tolerance Chart for Capacitors.

MULTIPLIER		TOLERANCE		
for the number:	multiply by:	10 pF or less	letter	over 10 pF
0	1	± 0.1 pF	B	-
1	10	± 0.25 pF	C	-
2	100	± 0.5 pF	D	-
3	1,000	± 1.0 pF	F	± 1%
4	10,000	± 2.0 pF	G	± 2%
5	100,000	-	H	± 3%
-	-	-	J	± 5%
8	0.01	-	K	± 10%
9	0.1	-	M	± 20%

Voltage ratings, usually printed on the component, show how much voltage can safely be used without damaging the capacitor. The rating must be higher than the highest voltage in the circuit.

Install variable capacitors (trimmers or trimcaps) so that the common terminals of the device are aligned with the common solder pads on the card.

#### TRANSISTORS (Q)

Handle transistors with care. Protect them from mechanical injury. Use minimum heat when soldering. Transistors may be destroyed if their three leads are incorrectly positioned in the circuit. Identifying the emitter, collector, and base (EBC) terminals however, presents a problem; the body of the device may or may not be labelled; the circuit board may or may not be silk-screened; different manufacturers arrange the EBC leads differently. If in doubt, check with your dealer.

#### CRYSTALS AND OSCILLATORS (Y)

Crystals are delicate. A severe jolt may chip the crystal suspended in the metal case. Install crystals last to prevent excessive movement while working on other components. Fold the body of the device flat against the card before soldering if space is available on the card. Secure the crystal to the card with double-sided tape. Alternately, some boards have feed-thru holes or "grounding pads" at each side of the crystal so that the device can be soldered in place. Wrap a thin bare wire around the device, install the ends of the wire into the grounding pads, and solder. Use a minimum amount of heat to solder the wire to the case.

#### INTEGRATED CIRCUITS (IC)

Treat ICs with care. Handle them by the body, not the pins. Protect them from mechanical injury.

The power must be OFF when inserting or removing ICs or other devices. Excessive voltage, reversed polarity, short circuits, etc., can quickly destroy an IC. ICs must be correctly positioned in the circuit. Pin 1 of ICs can be identified by a "dot", a "triangle", a "1", a "notch", etc. Match pin 1 of ICs with pin 1 on the layout.

Metal-Oxide-Silicon (MOS) and Complementary Metal-Oxide-Silicon (CMOS) integrated circuits are very sensitive to static electrical discharge, and require special handling. Store them in their original shipping tubes or with their pins embedded in special conductive foam. Linear ICs are moderately sensitive, whereas Transistor-Transistor Logic (TTL) ICs are relatively insensitive to static discharge.

Firmware, software written into PROMs (Programmable Read-Only Memory), EPROMs (Erasable ROM), EEPROMs (Electrical EPROM), and PALs (Programmed Array Logic), is the responsibility of the builder and can be programmed according to the requirements of the individual. These devices are sensitive to static discharge.

Keep EPROMs away from direct sunlight. Ultraviolet (UV) radiation of sunlight may partially erase some of the information programmed in an EPROM. Protect them by applying a non-transparent piece of tape or label over the transparent window on top of the device.

Some boards are "chip sensitive" - i.e. they require ICs made by a specific manufacturer. They will not run unless the correct combination of chips are installed. This involves "chip-swapping" using ICs from different manufacturers.

## CARD INSTALLATION AND REMOVAL

### CARD INSTALLATION

Turn the POWER OFF before installing or removing devices, peripheral cards or hardware, or when changing switch settings. Failure to do so will likely result in circuit damage to the card, other cards, and the motherboard.

Discharge STATIC ELECTRICITY in your body by touching the metal case of the power supply.

Orientate the peripheral card so that the COMPONENT SIDE faces the power supply. Position the card carefully in the slot so that no "sliding" FRONT-TO-BACK movement occurs. This abrasive movement may strip the thin gold layer from the fingers of the card. On the other hand, if a card runs intermittently, try cleaning the gold contacts by gently rubbing them with a soft eraser.

Insert the fingers of the card into the appropriate edge connector. Rock the card from FRONT-TO-BACK while gently applying downward pressure. Refer to Fig. 5 for the front-to-back orientation. The card must be firmly seated in the slot before turning on the power.

### CARD REMOVAL

POWER OFF  
DISCHARGE STATIC ELECTRICITY  
ROCK FRONT-TO-BACK WHILE APPLYING UPWARD PRESSURE

PRECAUTIONS

- Do NOT rock the card from side-to-side.
- Do NOT touch the gold-plated contact fingers of the card.
- Do NOT unnecessarily install and remove cards. Some poor quality card-edge connectors may break down, creating poor or non-existent contacts.
- Do NOT apply excessive force: you may flex the mother-board sufficiently to break one or more of the tracks.

▲ TO BACK OF COMPUTER ▲

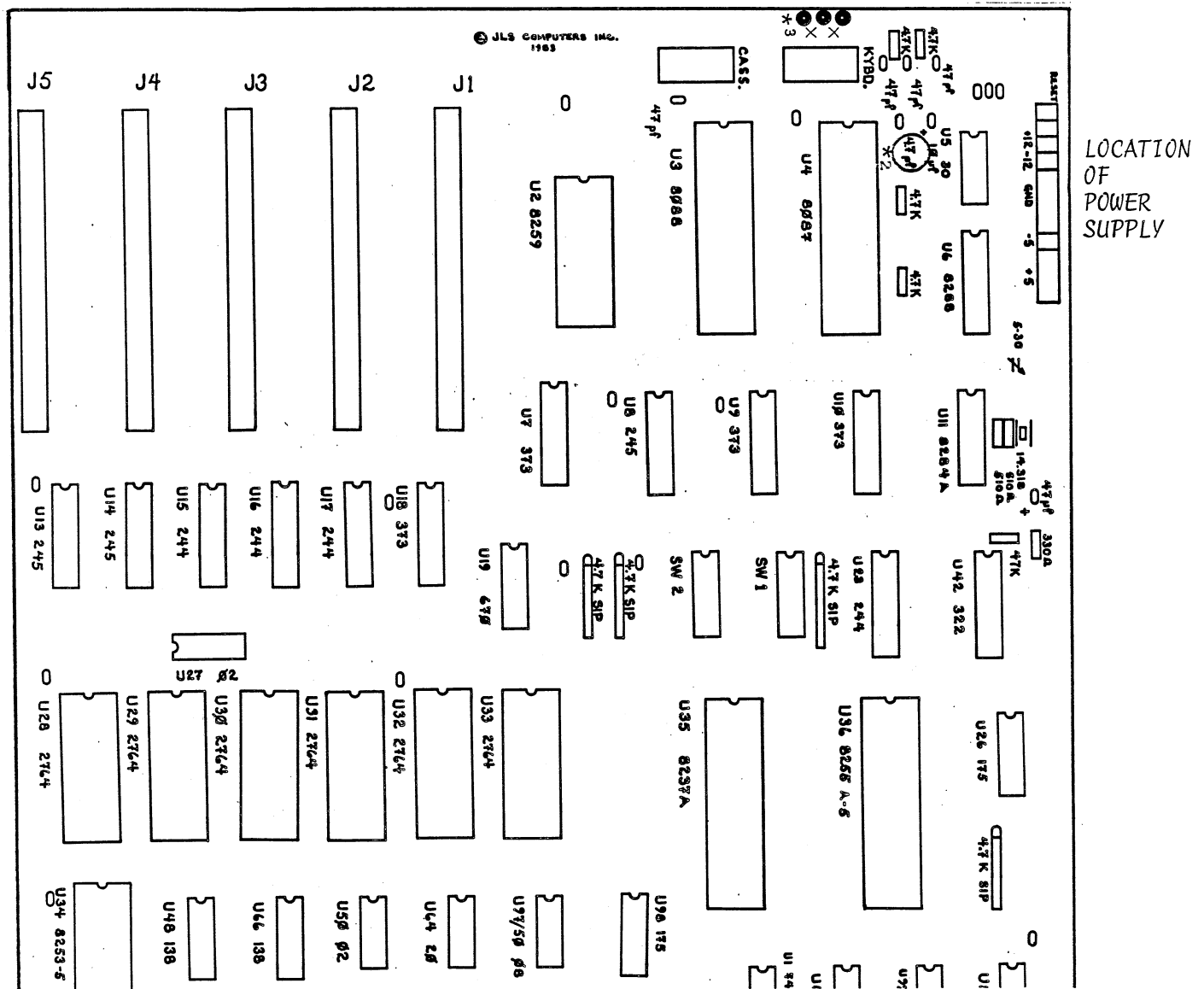

▼ TO FRONT OF COMPUTER ▼

FIG. 5. A PORTION OF THE TOP VIEW OF THE MOTHERBOARD SHOWING FRONT-TO-BACK ORIENTATION AND LOCATION OF THE POWER SUPPLY.

# CARD AND CONNECTOR PINOUT

Refer to Fig. 6 for the edge connector and peripheral card pinouts. The reproductions are close to original size. To quickly identify any one of the pins or contacts, lay the card along the edge of the centre diagram and directly read off the pin number. Do NOT mistakenly interchange the component side with the solder side. Note that the relative position of the power supply is normally to the right of the motherboard.

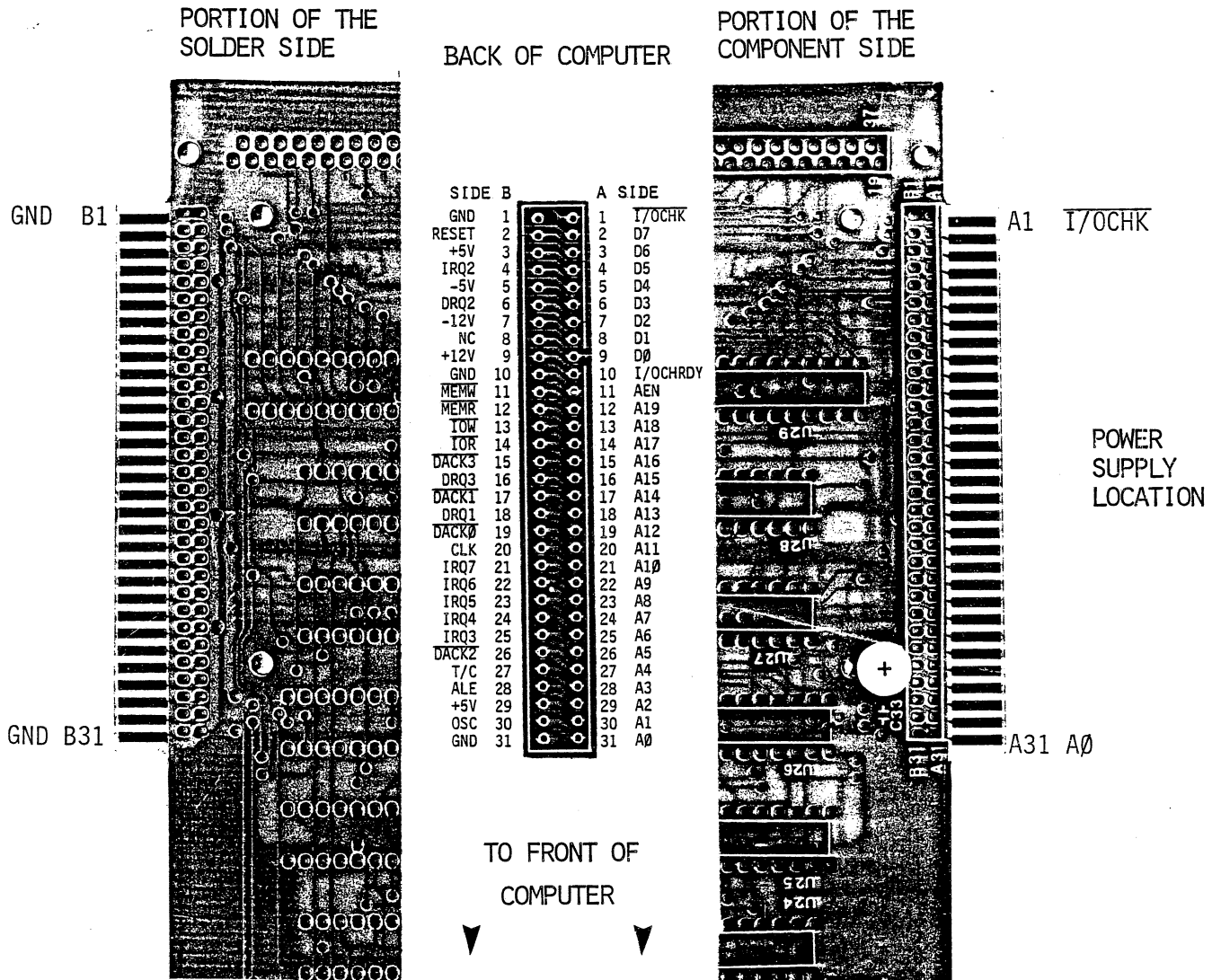

## SYSTEM UNIT HARDWARE

### POWER SUPPLY

A switching-type power supply provides power to the system motherboard, peripheral cards, disk drives, and keyboard. Select one with sufficient reserve power to handle all present and future options. Memory and disk drives are the major current users. Refer to Table III for a comparison of various units.

Table III. Comparison of Various Power Supplies (current in amperes)

power supply	potential difference (volts DC)				power (watts)	power for
	+5	+12	-12	-5		
IBM PC original	7.0	2.0	0.25	0.3	63.5	basic system
IBM XT original	15	4.2	0.25	0.3	129.9	all peripherals including hard drive
Apple-type	7	3	1	1	88.0*	basic system
compatible 100 watt	10	3.5	0.5	0.5	100.5	all peripherals plus lo-power slim-line hard disk drive
compatible 130 watt	15	4.5	0.5	0.5	137.5	all peripherals including hard drive

\*To determine the total power, multiply the current times the voltage and add:

amperes x volts = watts

7	+5	35.0
3	+12	36.0
1	-12	12.0
1	-5	5.0
		<u>88.0</u> watts

The power supply is connected to the motherboard by means of a 12-pin Molex-type connector. Some motherboards illustrated in this manual, e.g. GUIDE XT-2, MBE motherboard, have an optional "P3" connector for use with the popular Apple-type power supply.

Usually two 4-pin drive connectors are available to supply power to a pair of 5 1/4" floppy disk drives. A third drive connector, found on the 130 watt power supply, is used to power a hard disk drive. Some power supplies have four disk drive connectors. The following figure illustrates the pinouts for the power to the motherboard and disk drive.

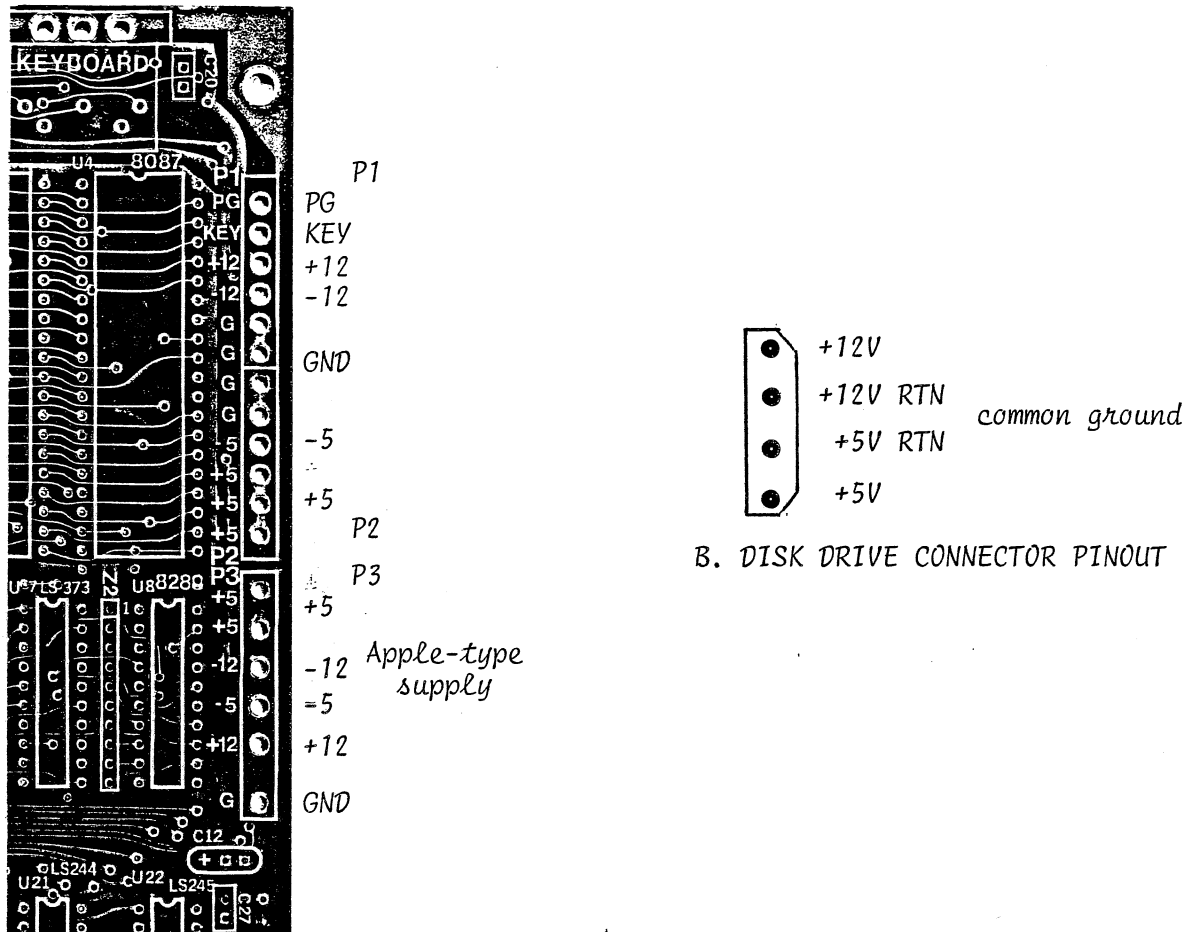

A. MOTHERBOARD POWER SUPPLY PINOUT

FIG. 7. PINOUTS FOR A. MOTHERBOARD AND B. DISK DRIVE CONNECTOR.

### CASE

Purchase a case and power supply together as a matched pair. Check that the cutouts in the case align with the switch, power cord connector, AC outlet, and fan vent of the power supply.

Select a case with slot spacings that match those on the motherboard. PC-compatible cases normally have five slots with a slot spacing of 25 mm. On the other hand, XT-compatible cases have eight slots with a slot spacing of 20 mm. Furthermore, rear panel adapters differ in width: a PC adapter is 25 mm, whereas an XT adapter is 18 mm wide.

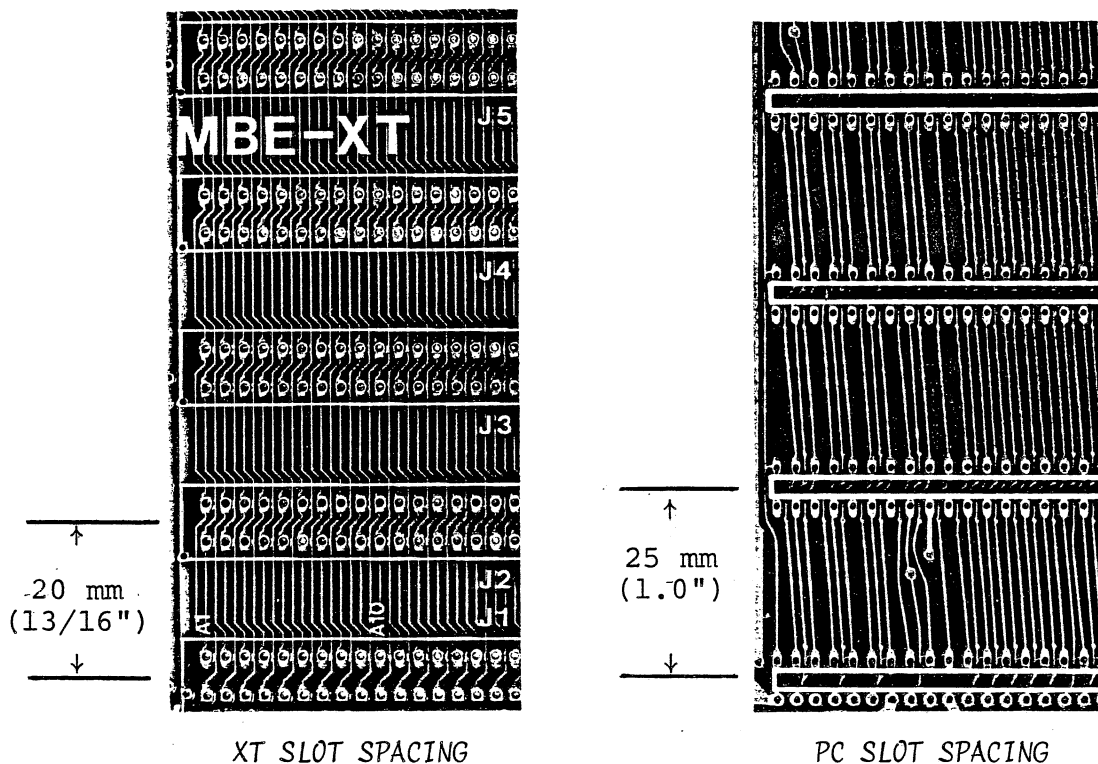

FIG. 8. XT AND PC MOTHERBOARD SLOT SPACING (center-to-center)

#### FAN

The power supply should have a built-in fan to circulate air and prevent overheating. Replace the fan with a more powerful one if the surface of the case becomes too hot, especially when using a hard disk drive. Install a fan in the case when using the Apple-type power supply.

Orient the fan so that hot air is drawn from the top of the case and exhausted out the rear or out the bottom when using the Apple-type power supply.

## APPENDIX

### ABBREVIATIONS

Alt	- Alternate
B	- Base (Transistor)
BIT	- Binary digIT
BYTE	- a group of 8 BITS
C	- Collector (Transistor)
C	- letter code for Capacitor
CharGen	- Character Generator
CMOS	- Complementary Metal-Oxide-Silicon
Cont	- Controller
CP/M	- Control Program for Microprocessors
CPU	- Central Processing Unit
CRT	- Cathode Ray Tube
D	- letter code for Diode
DIN	- European type connector
DIP	- Dual In-line Package
D.C.	- Direct Current
DOS	- Disk Operating System
DRAM	- Dynamic RAM
DPDT	- Double-Pole, Double-Throw
DUART	- Dual Asynchronous Receiver Transmitter
E	- Emitter (Transistor)
EPROM	- Erasable PROM
FDC	- Floppy Disk Controller
FET	- Field Effect Transistor
GND	- Ground
HIRES	- High Resolution
Hz	- Hertz
IC	- Integrated Circuit
IEEE	- Institute of Electrical and Electronic Engineers
I/O	- Input/Output
J	- Jumper
K	- Kilobyte, 1,024 bytes
L	- letter code for Coil or Inductor
LED	- Light Emitting Diode
LPT	- Line PrinTer
M	- Megabyte, 1,024,000 bytes
MOS	- Metal-Oxide-Silicon
MPU	- Microprocessing Unit
-ve	- negative
NiCad	- Nickel Cadmium
ns	- nano second
+ve	- positive
P	- post
PAL	- Programmed Aray Logic
PC	- Printed Circuit
PCB	- Printed Circuit Board
PG	- Power Good
PROM	- Programmable ROM

Q - letter code for Transistor  
 R - letter code for Resistor  
 R - Ring  
 RAM - Random-Access Memory  
 RF - Radio Frequency  
 RGB - Red, Green, Blue  
 RN - Resistor Network  
 ROM - Read-Only Memory  
 RTN - Return  
 S - Schottky  
 S, SW - Switch  
 S, SPKR - Speaker  
 SIP - Single In-line Package  
 SPDP - Single-Pole, Double-Throw  
 TP - Terminal Post  
 Trimcap - Trim capacitor  
 Trimpot - Trim potentiometer  
 TTL - Transistor-Transistor Logic  
 UV - Ultra Violet  
 V - Volt  
 Vid - Video  
 VR - Variable Resistor  
 XTAL - Crystal  
 XTL - Crystal  
 Y - letter code for Crystal  
 ZIF - Zero Insertion Socket

**METRIC PREFIXES** Decimal points and large numbers are avoided.

p	pico	$10^{-12}$
n	nano	$10^{-9}$
	micro	$10^{-6}$
m	milli	$10^{-3}$
-	-	$10^0$
k	kilo	$10^3$
M	mega	$10^6$
G	giga	$10^9$

**PART II**

**MOTHERBOARD AND PERIPHERAL CARD**

**ASSEMBLY GUIDES**

Study PART I, GUIDELINES TO SUCCESS, before attempting to assemble any of the following bare cards or boards.

GUIDE PC-1

JLS OBM-100 MOTHERBOARD: Features include: 8088 MPU with socket for optional 8087 co-processor; five I/O expansion slots, PC spacing of 25 mm; no on-board memory; six ROM sockets; cassette port available; schematics available from supplier.

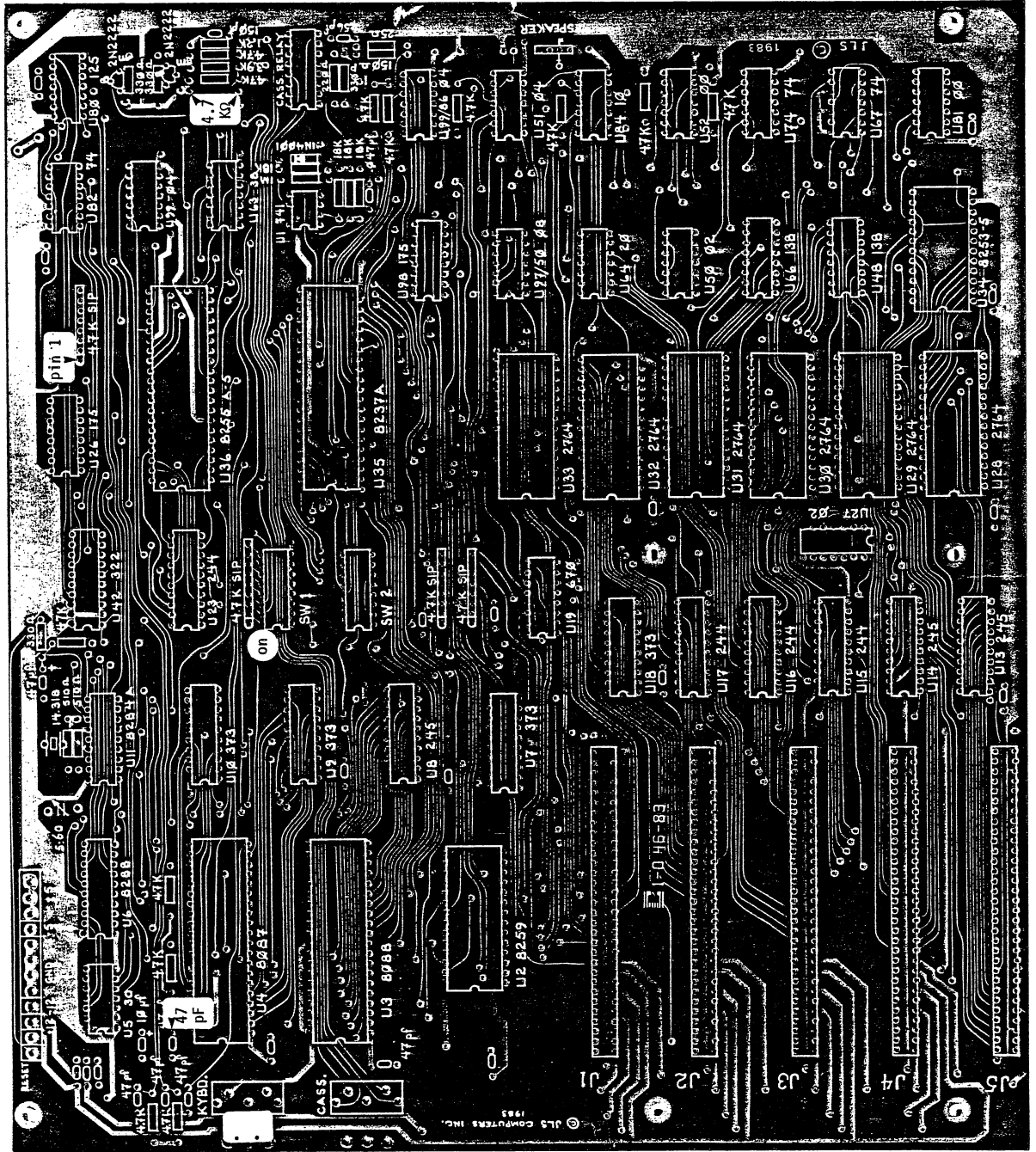

actual size  
29.1 cm x 25.7 cm  
(layout is reduced)

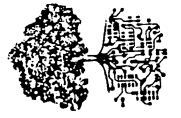

JLS OBM-100 MOTHERBOARD (continued):

SUGGESTED SEQUENCE \*INDICATES A PRECAUTION \*MODIFICATION REQUIRED

DIODES D \*Position banded (cathode) end of diode as shown  
 1 - 1N4001 ●→ cathode end

RESISTORS R 1/4 watt, 5%

- 1 - 150 Ω
- 1 - 220 Ω
- 4 - 330 Ω
- 2 - 510 Ω
- 1 - 1.2 KΩ
- 1 - 3.9 KΩ
- 13 - 4.7 KΩ \*Install a 4.7 K resistor as shown on the layout
- 4 - 18 KΩ
- 1 - 47 KΩ
- 1 - 1 MΩ
- 3 - 4.7 KΩ 8-pin SIP\*
- 1 - 4.7 KΩ 9-pin SIP\*

\*Match pin 1 of SIPs as shown on the layout

SOCKETS \*Match pin 1 of sockets with pin 1 on the layout. Check that ALL pins have passed thru ALL holes



- 1 - 8-pin
- 16 - 14-pin
- 6 - 16-pin
- 1 - 18-pin
- 13 - 20-pin
- 1 - 24-pin
- 7 - 28-pin
- 4 - 40-pin

CAPACITORS C

- 5 - 47 pF
  - 1 - 150 pF
  - 1 - 0.047 μF
  - 21 - 0.1 μF Monolithic @
  - 1 - 5-50 pF Trimcap @ 5-60
- \*Match + of the following capacitors with + on the layout
- 1 - 10 μF/16V Tantalum\*
  - 1 - 47 μF/16V Tantalum\*

INTEGRATED CIRCUITS (continued)

- 1 - LM741 @ U1
- 1 - 8088 MPU @ U3
- 1 - 8237A-5 @ U35
- 1 - 8253-5 @ U34
- 1 - 8255A-5 @ U36
- 1 - 8259A @ U2
- 1 - 8284A @ U11
- 1 - 8288 @ U6
- 1 - 2764 Boot EPROM @ U33

MODIFICATIONS \*ON THE SOLDER SIDE  
 1 - Cut trace between pin 3 & 4 of U82 (74LS74) on the SOLDER SIDE (if required)

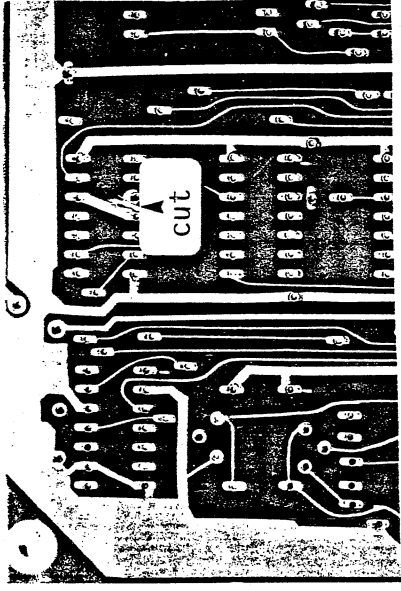

INTEGRATED CIRCUITS \*Match pin 1 of ICs with pin 1 on the layout

- 2 - 74LS00 @ U52,81
- 2 - 74LS02 @ U27,50
- 3 - 74LS04 @ U51,99,99/86
- 1 - 74LS08 @ U97/50
- 1 - 74LS10 @ U84
- 1 - 74LS20 @ U64
- 1 - 74LS30 @ U5
- 1 - 74LS38 @ U63
- 3 - 74LS74 @ U67,74,82
- 1 - 74LS125 @ U80
- 2 - 74LS138 @ U48,66
- 2 - 74LS175 @ U26,98
- 4 - 74LS244 @ U15,16,17,23
- 3 - 74LS245 @ U8,13,14
- 1 - 74LS322 @ U42
- 4 - 74LS373 @ U7,9,10,18
- 1 - 74LS670 @ U19

JLS OBM-100 MOTHERBOARD (continued):

SWITCH # 1 SETTINGS:

POSITION 2: remains off - reserved for the co-processor  
POSITIONS 3 & 4: remain off - indicate a minimum configuration of 64K bytes

POSITIONS 5 & 6: define video board type as follows:

video board type	settings
colour (40x25)	5 6
colour (80x25)	..... off on
black/white or both..	..... on off
none .....	..... off off
	..... on on

POSITIONS 1, 7 & 8: define the number of floppy disc drives in use:

number of drives	settings
0	1 7 8
1	..... on on on
2	..... off on on
3	..... off off on
4	..... off on off
	..... off off off

SWITCH # 2 SETTINGS:

POSITIONS 5, 6, 7 & 8: always remain off

POSITIONS 1, 2, 3 & 4: qualify memory as follows:

memory	settings
64K	1 2 3 4
128K	..... on on on on
192K	..... on off on on
256K	..... on on off on
	..... on off off on

SET # 5 to on when using a hard disk drive

GUIDE PC-2

**HAL COMPUTER MOTHERBOARD:** Features include: 8088 MPU with socket for optional 8087 co-processor; five I/O expansion slots, PC spacing of 25 mm; no on-board memory; six ROM sockets; cassette port available; documentaion and schematics available from supplier.

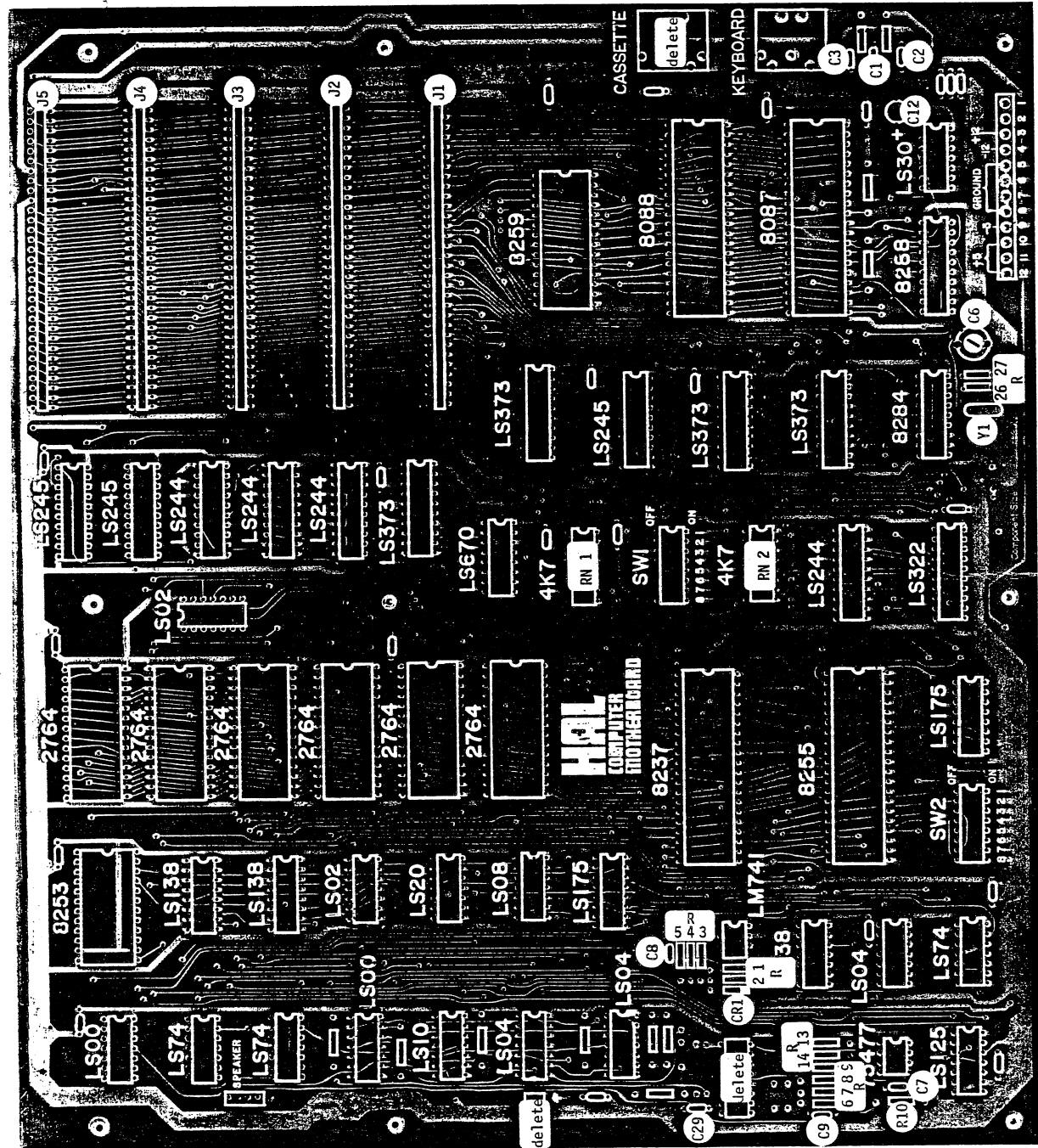

actual size  
29.4 cm x 26.3 cm  
(layout is reduced)

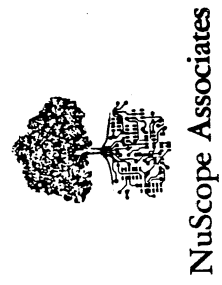

HAL COMPUTER MOTHERBOARD (continued)



SUGGESTED SEQUENCE \*INDICATES A PRECAUTION

DIODES D \*Position banded (cathode) end of diode as shown

1 - 1N4001



RESISTORS R 1/4 watt, 5% cathode end

- 1 - 47 Ω @ R10
- 2 - 150 Ω @ R6,25
- 3 - 1.2 KΩ @ R7,26,27
- 1 - 3.9 KΩ @ R9
- 13 - 4.7 KΩ @ positions  positions 
- 4 - 18 KΩ @ R1,3,4,5
- 1 - 1 MΩ @ R2
- 2 - 4.7 KΩ 16-pin DIP @ RN1,2

\*Solder DIPs to the board

SOCKETS \*Match pin 1 of sockets with pin 1 on the layout. Check that ALL pins have passed thru ALL holes

- 2 - 8-pin
- 14 - 14-pin
- 8 - 16-pin
- 1 - 18-pin
- 13 - 20-pin
- 1 - 24-pin
- 7 - 28-pin
- 4 - 40-pin

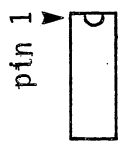

CAPACITORS C

- 4 - 56 pF @ C1,2,3,29
- 2 - 0.01 μF @ C7,9
- 1 - 0.047 μF @ C8
- 22 - 0.1 μF Monolithic @ 
- 1 - 5-60 pF Trimpac @ C6
- 1 - 10 μF/16V Axial\* @ C12

\*Match + of Axial with + on the layout

CRYSTAL Y \*Fold crystal flat against the board before soldering

1 - 14.31818 MHz

SWITCH

2 - 8-position DIP

CONNECTORS

- 1 - 12-pin male, straight, (Molex) for power
- 1 - 1x4 header, male, 90° for speaker (pins 1&4)
- 1 - 5-pin DIP for keyboard
- 5 - 62-pin card edge connectors

INTEGRATED CIRCUITS \*Match pin 1 of ICs with pin 1 on the layout

- 2 - 74LS00
- 2 - 74LS02
- 3 - 74LS04
- 1 - 74LS08
- 1 - 74LS10
- 1 - 74LS20
- 1 - 74LS30
- 1 - 74LS38
- 3 - 74LS74
- 1 - 74LS125
- 2 - 74LS138
- 2 - 74LS175
- 4 - 74LS244
- 3 - 74LS245
- 1 - 74LS322
- 4 - 74LS373
- 1 - 74LS670
- 1 - LM741
- 1 - 75477

INTEGRATED CIRCUITS (continued)

- 1 - 8087 (optional)
- 1 - 8088 MPU
- 1 - 8237A-5
- 1 - 8253-5
- 1 - 8255A-5
- 1 - 8259A
- 1 - 8284A
- 1 - 8288
- 1 - 2764 Boot EPROM @ U26
- 5 - 2764 EPROMs @ U21,22,23, U24,25 (optioal)

HAL COMPUTER MOTHERBOARD (continued):

**SWITCH SETTINGS - MOTHERBOARD SWITCH 1**

SW1 positions 1, 7 and 8 are set to indicate the number of floppy disks:

Number of Drives	Switch Positions		
	7	8	
0	ON	ON	ON
1	OFF	ON	ON
2	OFF	OFF	ON
3	OFF	ON	OFF
4	OFF	OFF	OFF

SW1 position 2 is always ON and SW1 positions 3 and 4 are always OFF.

SW1 positions 5 and 6 are set to the type of monitor in use:

Monitor Type	Switch Positions	
	5	6
None	ON	ON
Color (40 by 25)	OFF	ON
Color (80 by 25)	ON	OFF
Black and White (or both)	OFF	OFF

**SWITCH SETTINGS - MOTHERBOARD SWITCH 2**

SW2 position 1 is always set ON.

SW2 positions 2, 3 and 4 indicate memory used:

Amount of Memory	Switch Positions			
	2	3	4	
64k	ON	ON	ON	ON
128k	OFF	ON	ON	ON
192k	ON	OFF	ON	ON
256k	OFF	OFF	ON	ON
320k	ON	ON	OFF	OFF
384k	OFF	ON	OFF	OFF
448k	ON	OFF	OFF	OFF
512k	OFF	OFF	OFF	OFF

SW2 positions 5, 6, 7 and 8 are always set OFF.

### GUIDE PC-3

**ECS MOTHERBOARD:** Features include: 8088 MPU with socket for optional 8087 co-processor; five I/O expansion slots, PC spacing of 25 mm; no on-board memory; six ROM sockets; cassette port available.

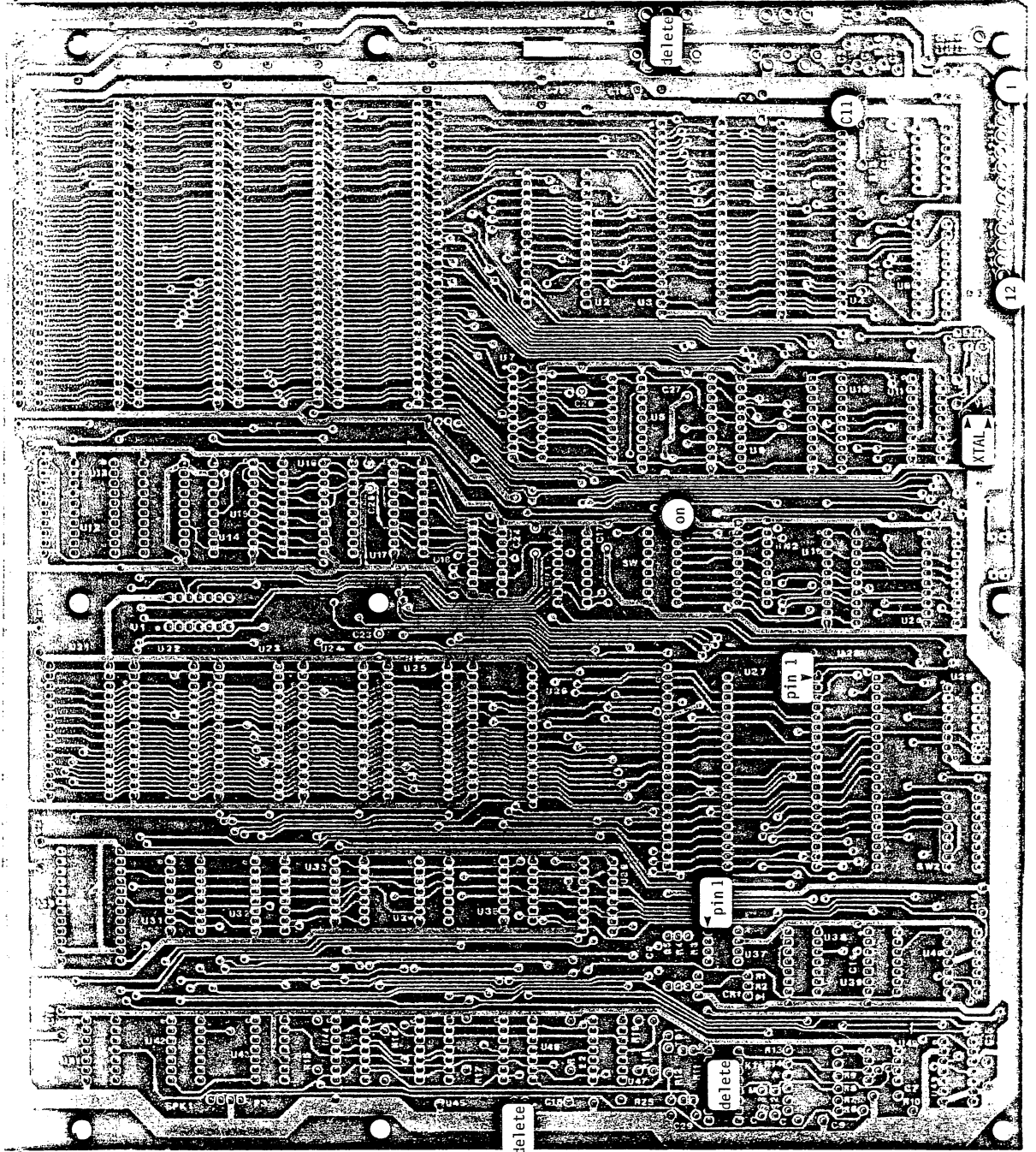

actual size  
29.3 cm x 26.0 cm  
(layout is reduced)

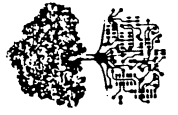

NuScope Associates

ECS MOTHERBOARD (continued):

DIODES D \*Position banded (cathode) end of diode towards the arrow cathode  
 1 - 1N4001

RESISTORS R 1/4 watt, 5%  
 1 - 47 Ω @ R10  
 2 - 150 Ω @ R6,25  
 1 - 220 Ω @ R11  
 1 - 330 Ω @ R12  
 3 - 1.2 KΩ @ R7,26,27  
 1 - 3.9 KΩ @ R9  
 13 - 4.7 KΩ @ R8,13,14,15,16,17,18,19,20,21,22,23,24  
 4 - 18 KΩ @ R1,2,3,4  
 1 - 1 MΩ @ R2  
 2 - 4.7 KΩ 16-pin DIP @ RN1,2  
 \*Solder directly to the board

SOCKETS \*Match pin 1 of sockets with pin 1 (dot) on the layout. Check that ALL pins have passed thru ALL holes

pin 1  
 2 - 8-pin  
 14 - 14-pin  
 8 - 16-pin  
 1 - 18-pin  
 13 - 20-pin  
 1 - 24-pin  
 7 - 28-pin  
 4 - 40-pin

CAPACITORS C  
 4 - 56 pF @ C1,2,3,29  
 2 - 0.01 μF @ C7,9  
 1 - 0.047 μF @ C8  
 23 - 0.1 μF Monolithic @ C4,5,10,11,13,14,15,16,17,18,19,20,21,22,23,24,25,26,27,28,30,31,32

CAPACITORS (continued)  
 1 - 5-60 pF Trimcap @ C6  
 1 - 10 μF/16V Axial\* @ C12  
 \*Match + of Axial with + on the layout  
 CRYSTAL Y \*Fold crystal flat against the board before soldering  
 1 - 14.31818 MHz @ Y1  
 SWITCH  
 2 - 8-position DIP @ SW1,2  
 CONNECTORS  
 1 - 1X4 header, male, 90° @ P3 for speaker (pins 1&4)  
 1 - 5-pin DIN @ J7 for keyboard  
 5 - 62-pin card edge connectors @ J1,2,3,4,5  
 1 - 12-pin Molex, straight @ P1 for power

PINOUT FOR POWER:  
 pin for  
 1 -  
 2 -  
 3 - +12  
 4 - -12  
 5,6,7,8 GND  
 9 - -5  
 10,11,12 +5

INTEGRATED CIRCUITS \*Match pin 1 of ICs with pin 1 (dot) on the layout  
 2 - 74LS00 @ U41,44  
 2 - 74LS02 @ U1,33  
 3 - 74LS04 @ U39,46,47  
 1 - 74LS08 @ U35  
 1 - 74LS10 @ U45  
 1 - 74LS20 @ U34  
 1 - 74LS30 @ U5  
 1 - 74LS38 @ U38  
 3 - 74LS74 @ U40,42,43  
 1 - 74LS125 @ U49  
 2 - 74LS138 @ U31,32  
 2 - 74LS175 @ U29,36  
 4 - 74LS244 @ U14,15,16,19  
 3 - 74LS245 @ U8,12,13  
 1 - 74LS322 @ U20  
 4 - 74LS373 @ U7,9,10,17  
 1 - 74LS670 @ U18  
 1 - LM41 @ U37  
 1 - 75477 @ U48  
 1 - 8087 @ U4 (optional)  
 1 - 8088 @ U3 MPU  
 1 - 8237A @ U27  
 1 - 8253-5 @ U30  
 1 - 8255A-5 @ U28  
 1 - 8259A @ U2  
 1 - 8284A @ U11  
 1 - 8288 @ U6  
 1 - 2764 @ U26 Boot EPROM  
 5 - 2764 @ U21,22,23,24,25 (optional)

(1) 11/8/80 rev. from 10-20-80

ECS MOTHERBOARD (continued):

SWITCH # 1 SETTINGS:

POSITION 2: remains off - reserved for the co-processor  
POSITIONS 3 & 4: remain off - indicate a minimum configuration of 64K bytes

POSITIONS 5 & 6: define video board type as follows:

video board type	settings
colour (40x25)	5 6
colour (80x25)	..... off on
black/white or both	..... on off
none	..... off off
	..... on on

POSITIONS 1, 7 & 8: define the number of floppy disc drives in use:

number of drives	settings
	1 7 8
0	..... on on on
1	..... off on on
2	..... off off on
3	..... off on off
4	..... off off off

SWITCH # 2 SETTINGS:

POSITIONS 5, 6, 7 & 8: always remain off

POSITIONS 1, 2, 3 & 4: qualify memory as follows:

memory	settings
	1 2 3 4
64K	..... on on on on
128K	..... on off on on
192K	..... on on off on
256K	..... on off off on

GUIDE XT-1

**ROBIN HOOD MOTHERBOARD: FEATURES:** 8088 MPU with socket for optional 8087 co-processor; eight I/O expansion slots, XT spacing of 20 mm; on-board memory in blocks of 64 K to a maximum of 256 K using 4164 or equivalent RAM ICs; eight ROM sockets; documentation and schematics available from supplier.

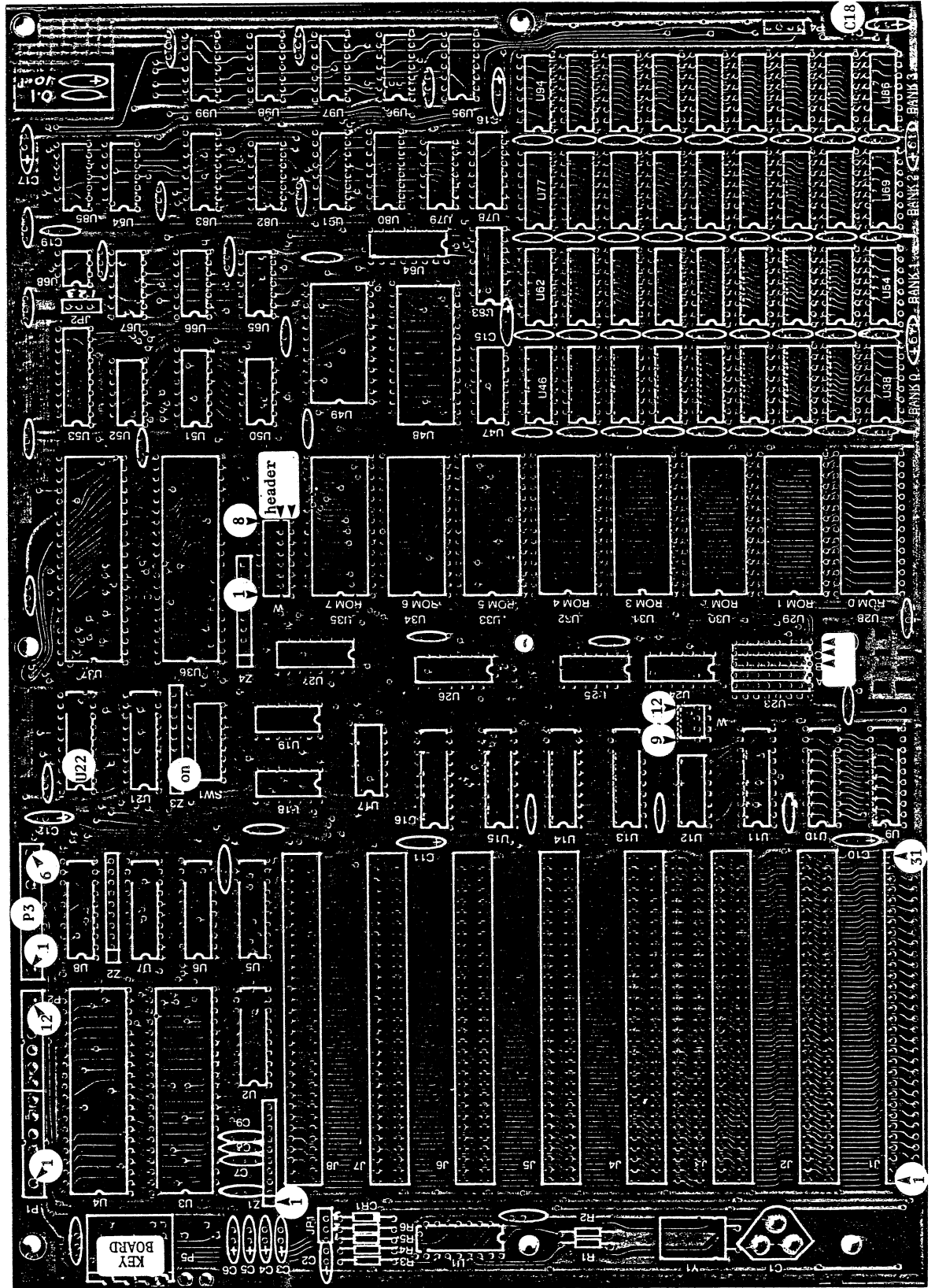

actual size  
30.3 cm x 21.6 cm  
(layout is reduced)

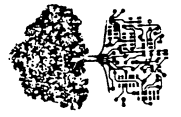

**ROBIN HOOD XT MOTHERBOARD: SUGGESTED SEQUENCE \*INDICATES A PRECAUTION**

**DIODES** D \*Position banded (cathode) end of diode towards the bar  
 1 - 1N4148 (1N914) @ CR1 @ CR1 cathode

**RESISTORS** R 1/4 watt, 5%  
 3 - 27 Ω @ R3,4,5  
 2 - 510 Ω @ R1,2  
 1 - 1 KΩ @ R6  
 2 - 33 Ω 16-pin DIP @ U63,78

Solder directly to the board  
 Sixteen 33 Ω resistors may be substituted for the two DIP packages  
 4 - 4.7 KΩ 10-pin SIP\* @ Z1,2,3,4  
 \*Match pin 1 of SIPs with pin 1 (square) on the layout

**SOCKETS** \* Match pin 1 of sockets with pin 1 on the layout. Check that ALL pins have passed thru ALL holes  
 1 - 8-pin  
 19 - 14-pin  
 47 - 16-pin  
 1 - 18-pin  
 15 - 20-pin  
 1 - 24-pin  
 9 - 28-pin  
 4 - 40-pin

pin 1 for ALL sockets and ICs  
 CAPACITORS C  
 3 - 47 pF (50 pF) @ C7,8,9  
 1 - 0.01 μF @ C19  
 64 - 0.1 μF Monolithic\* @

\*Note TWO different spacing between pads. Select correct pads  
 14 - 10 μF/25V Tantalum\* @ C2,3,4,5,6,10,11,12,13,14,15, C16,17,18 \*Match + of Tantalum with + on the layout  
 1 - 5-50 pF Trimcap @ C1

**CRYSTAL** Y \*Fold crystal flat against the board before soldering. Solder the crystal case to the grounding pad on the board  
 1 - 14.31818 MHz @ Y1

**SWITCHES**  
 The following switch (SW1) is used to select the system configuration  
 1 - 8-position DIP  
 The following TWO switches (W) are used to select EPROM/ROM type.  
 Install 74LS138 IC @ U23 (A,B or C) accordingly  
 1 - 8-position DIP @ W (W1 to 8) (or 2x8 header)  
 1 - 4-position DIP @ W (W9 to 12) (or 2x4 header)

**CONNECTORS**  
 2 - 1x3 header, male, straight @ JP2 strap 2-3  
 1 - Jumper plug on pins 2 & 3 of JP1  
 1 - 1x4 header, male 90° @ P4 for speaker  
 1 - 12-pin power connector @ P1,P2  
 1 - 6-pin power connector @ P3 (Apple-type supply)  
 8 - 62-pin edge card connectors @ J1,2,3,4,5,6,7  
 1 - 5-pin DIN Keyboard connector @ P5

**DELAY LINE**

1 - 100 ns @ U95  
 INTEGRATED CIRCUITS \*Match pin 1 of ICs with pin 1 on the layout  
 1 - 74LS00 @ U85  
 2 - 74LS02 @ U24,97  
 2 - 74LS04 @ U18,67  
 1 - 74LS10 @ U84  
 2 - 74LS20 @ U12,66  
 1 - 74LS27 @ U17  
 1 - 74LS32 @ U50  
 2 - 74LS74 @ U52,82  
 3 - 74LS138 @ U23,51,81  
 2 - 74LS175 @ U27,83  
 6 - 74LS244 @ U6,9,10,11,16,21  
 4 - 74LS245 @ U2,13,14,22  
 1 - 74LS322 @ U53  
 3 - 74LS373 @ U5,7,15  
 1 - 74LS670 @ U26

2 - 74S00 @ U96,99  
 2 - 74S08 @ U79,98  
 1 - 74S74 @ U65  
 1 - 74S138 @ U80  
 2 - 74S157 @ U47,64  
 1 - 74S280 @ U25  
 1 - 7407 @ U19  
 1 - 75477 @ U68

1 - 8088 @ U3 MPU  
 1 - 8087 @ U4 (optional)  
 1 - 8237A-5 @ U36  
 1 - 8253-5 @ U49  
 1 - 8255A-5 @ U37  
 1 - 8259A @ U48  
 1 - 8284A @ U1  
 1 - 8288 @ U8

18 - 4164 DRAM 200ns standard @ U38-46 & U54-62  
 18 - 4164 DRAM 200 ns optional @ U69-77 & U86-94  
 1 - 2764 Boot EPROM 250 ns @ ROM 7  
 7 - 2764 EPROMs optional @ ROM 0,1,2,3,4,5,6

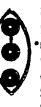

ROBIN HOOD XT MOTHERBOARD (continued)

SWITCH SW1 SETTINGS: SYSTEM CONFIGURATION

SWITCH #	1	2	3	4	5	6	7	8
OPERATING MODE	normal	8087	RAM	monitor	drive #			
	off	no 8087 with 8087	128K 192K 256K	off on on off off off	none 40x25 80x25 monochrome	on on on on on off off off	1 2 3 4	on on off on on off off off

EPROM/ROM SELECTION (SWITCHES W); LOCATION OF MEMORY DECODER (U23 74LS138):

W number	EPROM/ROM SELECTION								LOCATION OF U23				
	W - near ROM 7								W - near U12				
2764 EPROM	1	2	3	4	5	6	7	8	9	10	11	12	position
27128 EPROM	on	off	on	off	on	off	on	off	off	on	off	on	A
8Kx8 ROM	on	off	on	off	on	off	on	off	off	on	off	on	B
32Kx8 ROM	off	on	off	on	off	on	off	on	on	off	on	off	A
									on	off	on	off	C

GUIDE XT-2

**MBE-XT MOTHERBOARD:** Features include: 8088 MPU with socket for optional 8087 co-processor; eight I/O expansion slots XT spacing of 20 mm; on-board memory in blocks of 64 K to a maximum of 256 K using 4164 or equivalent RAM chips; eight ROM sockets; documentation and schematics available from supplier.

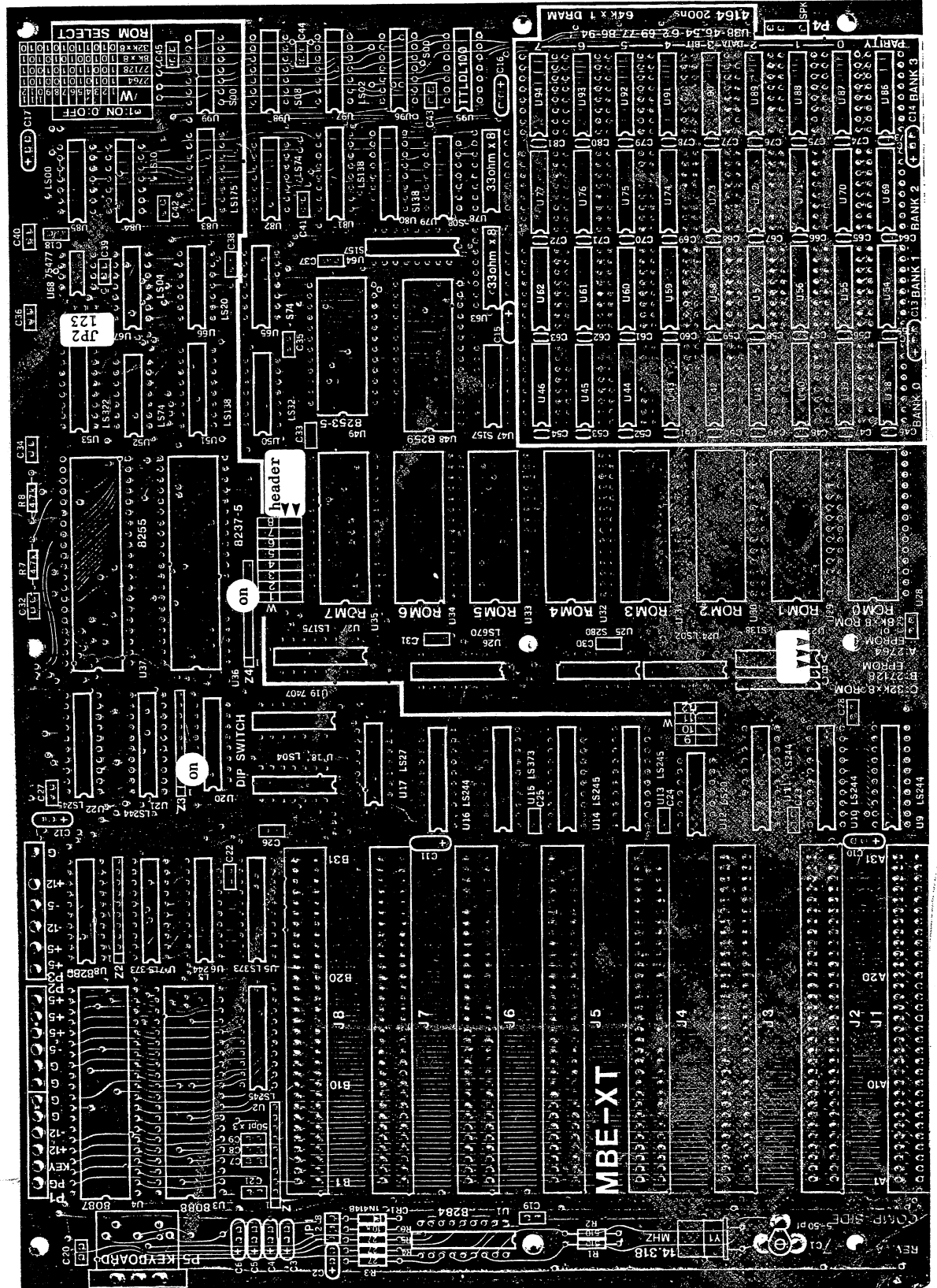

actual size  
30.3 cm x 21.5 cm  
(layout is reduced)

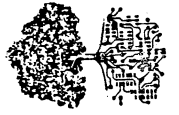

MBE-XT MOTHERBOARD (continued)

DIODE D \*Position banded (cathode) end of diode towards the arrow  
 1 - 1N4148 @ CRI

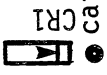

● cathode end

RESISTORS R 1/4 watt, 5%  
 3 - 27 Ω @ R3,4,5  
 2 - 510 Ω @ R1,2  
 2 - 4.7 KΩ @ R7,8  
 1 - 10 KΩ @ R6  
 4 - 4.7 KΩ 10-pin SIP\* @ Z1,2,3,4

\*Match pin 1 of SIPs with pin 1 (square) on the layout

2 - 33 Ω 16-pin DIP\* @ U63,78  
 \*Solder directly to the board

SOCKETS \*Match pin 1 of sockets with pin 1 on the layout. Check that ALL pins have passed thru ALL holes

1 - 8-pin  
 19 - 14-pin  
 45 - 16-pin  
 1 - 18-pin  
 15 - 20-pin  
 1 - 24-pin  
 9 - 28-pin  
 4 - 40-pin



pin 1 for ALL sockets and ICs

CAPACITORS C

3 - 50 pF (47 pF) @ C7,8,9  
 1 - 0.01 μF @ C18  
 62 - 0.1 μF Monolithic @ C19 to 81  
 13 - 10 μF/25V Tantalum\* @ C2,3,4,5,6  
 C10,11,12,13,14,15,16,17

\*Match + of Tantalum with + on the layout

1 - 5-50 pF Trimcap @ C1

CRYSTAL \*Fold crystal flat against the board before soldering. Solder the case to the grounding pad under crystal  
 1 - 14.31818 MHz @ Y1

SWITCHES

1 - 8-position DIP @ U20 for board setup for EPROM/ROM switch settings use EITHER DIP switches OR headers

1 - 8-position DIP @ W1-8  
 1 - 4-position DIP @ W9-12 OR

1 - 2x8 header, male straight @ W1-8  
 1 - 2x4 header, male straight @ W9-12  
 - - jumper plugs

CONNECTORS

2 - 1x3 header, male, straight @ JP1 for power reset @ JP2

1 - 1x4 header, male, straight @ P4 for speaker

1 - 12-pin power connector @ P1,P2

1 - 6-pin power connector @ P3 (Apple-type supply) @ J1,2,3,4,5,6,7,8

8 - 62-pin card edge connectors @ J1,2,3,4,5,6,7,8  
 1 - 5-pin DIN keyboard connector @ P5

DELAY LINE

1 - 100 ns @ U95

\*Solder directly to the board

INTEGRATED CIRCUITS \*Match pin 1 of ICs with pin 1 on the layout

1 - 74LS00 @ U85  
 2 - 74LS02 @ U24,97  
 2 - 74LS04 @ U18,67  
 1 - 74LS10 @ U84  
 2 - 74LS20 @ U12,66  
 1 - 74LS27 @ U17  
 1 - 74LS32 @ U50  
 2 - 74LS74 @ U52,82  
 3 - 74LS138 @ U23,51,81  
 2 - 74LS175 @ U27,83  
 6 - 74LS244 @ U6,9,10,11,16,21  
 4 - 74LS245 @ U2,13,14,22  
 1 - 74LS322 @ U53  
 3 - 74LS373 @ U5,7,15  
 1 - 74LS670 @ U26  
 2 - 74S00 @ U96,99  
 2 - 74S08 @ U79,98  
 1 - 74S74 @ U65  
 1 - 74S138 @ U80  
 2 - 74S157 @ U47,64  
 1 - 74S280 @ U25  
 1 - 7407 @ U19  
 1 - 75477 @ U68  
 1 - 8088 @ U3 MPU  
 1 - 8087 @ U4 (optional)  
 1 - 8237A-5 @ U36  
 1 - 8253-5 @ U49  
 1 - 8255A-5 @ U37  
 1 - 8259A @ U48  
 1 - 8284A @ U1  
 1 - 8288 @ U8  
 18 - 4164 RAM 200 ns (standard) @ U38-46 & U54-62  
 18 - 4164 RAM 200 ns (optional) @ U69-77 @ U86-94  
 1 - 2764 Boot EPROM 250 ns (standard) @ ROM 7  
 7 - 2764 EPROMs (optional) @ ROM 0-6

*Handwritten signature/initials*

MBE-XT MOTHERBOARD (continued)

SWITCH SW1 SETTINGS: SYSTEM CONFIGURATION

SWITCH #	1	2	3	4	5	6	7	8
OPERATING MODE	normal	off						
		8087			monitor		drive #	
	no 8087	on	RAM		none	on	1	on
	with 8087	off	128K	off	40x25 colour	on	2	off
			192K	on	80x25 colour	off	3	on
			256K	off	monochrome	off	4	off

EPROM/ROM SELECTION AND LOCATION OF MEMORY DECODER (U23 74LS138):

		EPROM/ROM SELECTION								LOCATION OF U23					
W number		W - near ROM 7				W - near U12				position					
		1	2	3	4	5	6	7	8	9	10	11	12		
2764 EPROM	on	off	on	off	on	off	on	off	on	off	on	off	on	A	
27128 EPROM	on	off	off	on	on	off	on	off	on	off	off	off	on	B	
8Kx8 ROM	on	off	on	off	off	on	off	on	off	off	on	off	on	A	
32Kx8 ROM	off	on	off	on	on	off	on	off	on	off	on	off	on	C	

GUIDE XT-3

**MEGA-BOARD MOTHERBOARD:** Features include: 8088 MPU with socket for optional 8087 co-processor; eight I/O expansion slots, XT spacing of 20 mm (connector J1 provides external bus expansion via a 62-pin gold-plated card edge connector; on-board memory in blocks of 64 K to a maximum of 256 K using 4164 or equivalent ICs, or to a maximum of 1 M using 256 K RAM ICs; five ROM sockets jumper programmable to accept 8,16,32,64 K ROM and EEPROM ICs; hardware reset switch; wire-wrap area; documentation and schematics available from supplier.

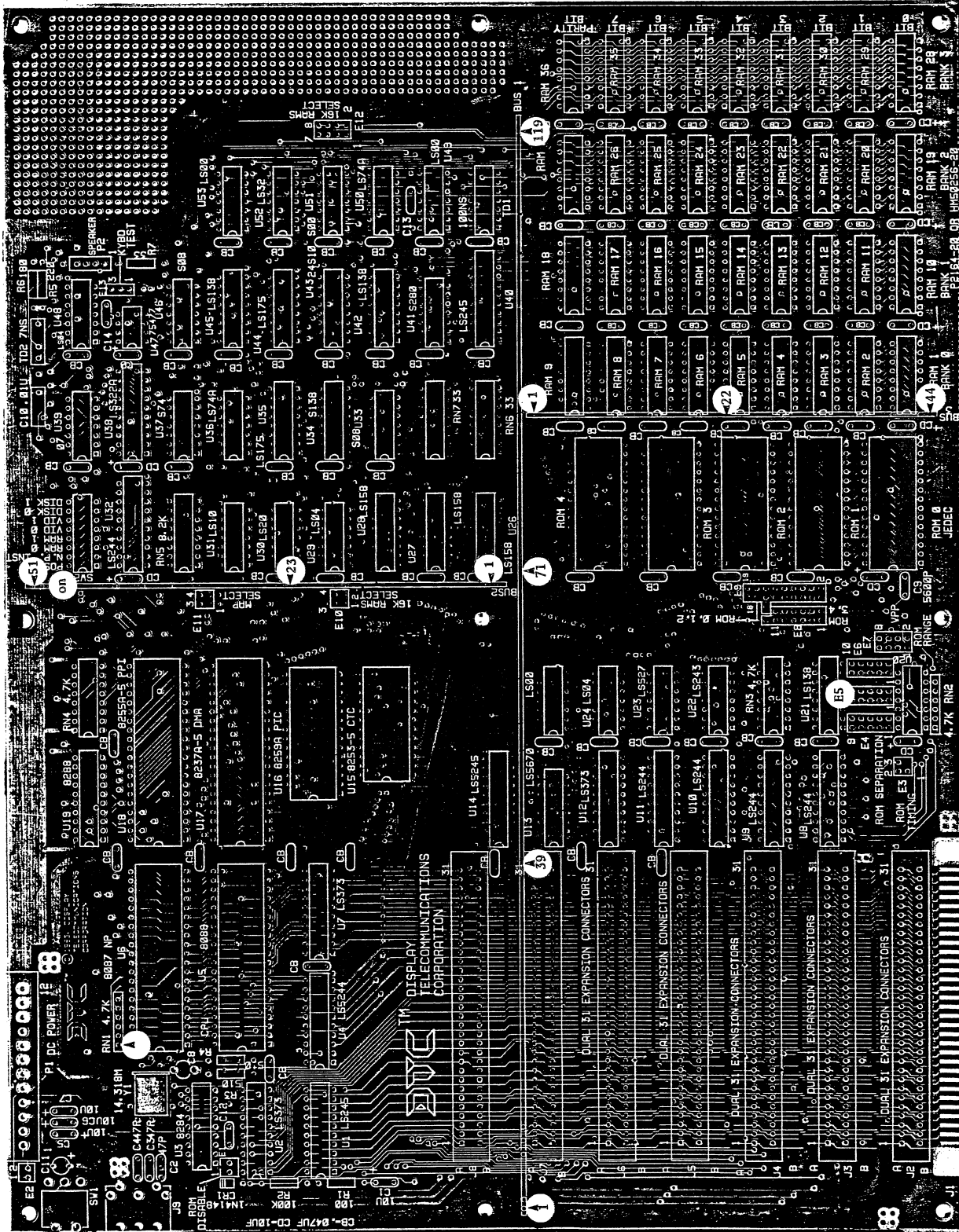

\*Not ALL bus bar pin numbers are shown

actual size  
34.3 cm x 26.6 cm  
(layout is reduced)



NuScope Associates

MEGA-BOARD MOTHERBOARD (continued)

SUGGESTED SEQUENCE \*INDICATES A PRECAUTION

Use the bare board as a guide to prepare the three bus bars. Install later.

DIODES D \*Position banded (cathode) end of diode as shown  
 1 - 1M4148 @ CR1

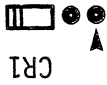

RESISTORS R 1/2 watt, 5%  
 1 - 33 Ω @ R7  
 1 - 100 Ω @ R1  
 1 - 180 Ω @ R6  
 1 - 220 Ω @ R5  
 2 - 510 Ω @ R3,4  
 1 - 100 KΩ @ R2  
 2 - 4.7 K 6-pin SIP\* @ RN1,2  
 \*Match pin 1 of SIPs with pin 1 on the layout

\*Solder the following DIP resistor networks directly to the board

1 - 330 Ω 16-pin DIP @ RN6,7  
 2 - 4.7 KΩ 16-pin DIP @ RN3,4  
 1 - 8.2 KΩ 16-pin DIP @ RN5

SOCKETS \*Match pin 1 of sockets with pin 1 on the layout. Check that ALL pins have passed thru ALL holes

1 - 8-pin  
 21 - 14-pin  
 53 - 16-pin  
 1 - 18-pin  
 14 - 20-pin  
 1 - 24-pin  
 6 - 28-pin  
 4 - 40-pin



pin 1 (square pad) for ALL sockets and ICs

CAPACITORS C  
 3 - 47 pF Monolithic @ C2,3,4  
 1 - 100 pF Monolithic @ C13  
 1 - 5600 pF Monolithic @ C9\*

\*For EEPROM programming only

CAPACITORS (continued)  
 1 - 0.01 μF Mylar, Axial @ C10  
 78 - 0.1 μF Monolithic @ C12,14 & positions CB (bypass) & positions CB @ C1,5,6, 14 - 10 μF/16V Tantalum\* @ C1,5,6, C7,11 & positions CD  
 \*Match + of Tantalums with + on the layout  
 1 - 6-30 pF Trimcap @ C8

CRYSTAL Y \*Fold crystal flat against the board before soldering. Solder case to grounding pad under crystal  
 1 - 14.31818 MHz @ Y1

SWITCH  
 1 - Miniature PB, momentary contact @ SW1  
 1 - 8-position DIP @ SW2

BUS BARS  
 3 - bus bars, 10 pins per inch Prepare in the following manner: Cut bus bars to length. Mark pins to be used with a felt pen. Remove unused pins with needle-nosed pliers. Check that tabs are cleanly removed and cannot cause a short circuit with the bar installed. Install and solder.  
 BUS 1: 30.0 cm Use pins 1,7,10,19,39,51,59,71,83,87,88,100,107,119  
 BUS 2: 12.9 cm Use pins 1,7,17,23,39,51  
 BUS 3: 11.1 cm Use pins 1,2,4,10,22,28,32,36,40,44

HEADERS All are male, straight  
 2 - 1x2 pins @ E2,3  
 3 - 2x5 pins @ E4,5,6  
 1 - 2x4 pins @ E7  
 \*E8 & E9 are non-standard

HEADERS (continued)  
 1 - 2x7 pins @ E8 \*Remove pin 14 before installing  
 1 - 2x9 pins @ E9 \*Add one pin at I3  
 1 - 1 pin @ VPP  
 1 - 1x4 pins @ P2 use pins 1 & 4

CONNECTORS  
 1 - 12-pin Molex, straight @ P1

PINOUT FOR POWER:  
 pin for:  
 1 Reset  
 2 Key  
 3 +12  
 4 -12  
 5,6,7,8 GND  
 9 -5  
 10,11,12 +5

1 - 5-pin DIN  
 7 - 62-pin card edge-connectors  
 DELAY LINES \*Solder to the board  
 1 - 100 ns digital @ TD1 \*Install in socket  
 1 - 7 ns inductive @ TD2\*\*  
 \*\*Required only for 256 K RAM chips - otherwise install one 150 Ω resistor & one 56 pF capacitor as shown on the layout

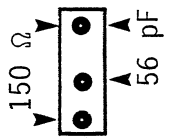

2X31 header  
 made by @ J1 for  
 fine print

1-1502 (C9K chip)

MEGA-BOARD MOTHERBOARD (continued)

INTEGRATED CIRCUITS \*Match pin 1 of ICs with pin 1 on the layout

- 3 - 74LS00 @ U25,49,53
- 3 - 74LS04 @ U24,29,48
- 1 - 74LS10 @ U31
- 1 - 74LS20 @ U30
- 1 - 74LS27 @ U23
- 1 - 74LS30 @ U20
- 1 - 74LS32 @ U52
- 2 - 74LS74 @ U36,50
- 3 - 74LS138 @ U21,42,45
- 3 - 74LS158 @ U26,27,28†
- 2 - 74LS175 @ U35,44
- 1 - 74LS243 @ U22
- 6 - 74LS244 @ U4,8,9,10,11,32
- 3 - 74LS245 @ U1,14,40
- 1 - 74LS322A @ U38
- 3 - 74LS373 @ U2,7,12
- 1 - 74LS670 @ U13
- 1 - 74S00 @ U51
- 2 - 74S08 @ U33,46
- 1 - 74S74 @ U37
- 1 - 74S138 @ U34
- 1 - 74S280 @ U41
- 1 - 7407 @ U39
- 1 - 75477 @ U47
- 1 - 8087 @ U6 (optional)
- 1 - 8088 @ U5 MPU
- 1 - 8237A-5 @ U17
- 1 - 8253-5 @ U15
- 1 - 8255A-5 @ U18
- 1 - 8259A @ U16
- 1 - 8284 @ U3
- 1 - 8288 @ U19

STRAPPING (continued)

FOR 64 K DRAM  
E10,11,12 not equipped  
FOR KEYBOARD TEST  
E13 not equipped

ROMs:  
Location starting address function  
ROM 0 F600 4th BASIC ROM  
ROM 1 F800 3rd BASIC ROM  
ROM 2 FA00 2nd BASIC ROM  
ROM 3 FE00 1st BASIC ROM  
ROM 4 FE00 boot ROM

STRAPPING Refer to documentation for a detailed description

\*Terminal numbering on E8 & E9 is non-standard, especially terminals 13,14,15 FOR ROM DISABLE:

E1 not equipped

FOR POWER RESET

E2 equip only if power supply provides pin 1 reset

FOR 64 K EPROMs (2764)

location strap

E3 1-2

E4,5,6 7-8

E7 3-4

E8 5-6

E9 7-8

1-3

5-6

8-10

11-12

1-2

5-7

10-12

14-15

18-19

SWITCH SW2 SETTINGS: SYSTEM CONFIGURATION

SWITCH #	1	2	3	4	5	6	7	8
OPERATING MODE	normal	8087	RAM	monitor	drive #			
	off	no 8087 with 8087	128K	none	1	on	on	on
	off	with 8087	192K	40x25 colour	2	on	off	on
			256K	80x25 colour	3	on	on	off
				monochrome	4	off	off	off

†Equip U28 only when using 256 K RAM ICs

GUIDE XT-4

**EKBM XT SYSTEM MOTHERBOARD:** Features include: 8088 MPU with socket for optional 8087 co-processor; eight I/O expansion slots, PC spacing of 25 mm; on-board memory in blocks of 64 K to a maximum of 256 K using 4164 or equivalent chips; eight ROM sockets; documentation available from supplier.

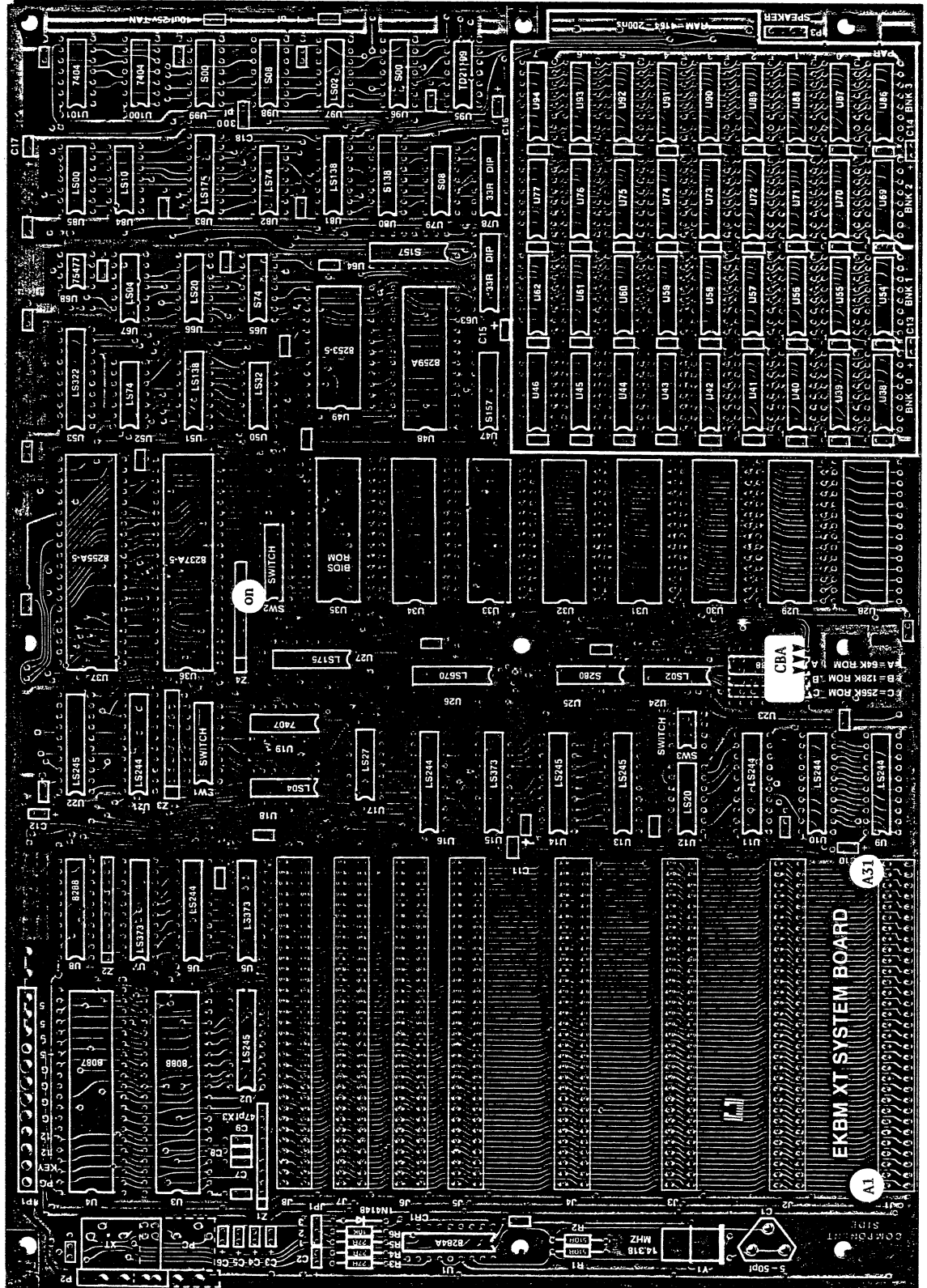

actual size  
30.3 cm x 21.6 cm  
(layout is reduced)



### EKBM XT SYSTEM MOTHERBOARD (continued)

DIODE D \*Position banded (cathode) end of diode towards the arrow  
 1 - 1N4148 @ CR1

RESISTORS R ¼ watt, 5%  
 3 - 27 Ω @ R3,4,5  
 2 - 510 Ω @ R1,2  
 1 - 10 KΩ @ R6  
 4 - 4.7 KΩ 10-pin (9 resistor) SIP\* @ Z1,2,3,4 \*Match pin 1 of SIPs with the square on the layout

2 - 33 Ω 16-pin DIP @ U63,78  
 \*Solder directly to the board. (Eight 33 Ω resistors may be substituted for each DIP)

SOCKETS \*Match pin 1 of sockets with pin 1 on the layout. Check that ALL pins have passed thru ALL holes

- 1 - 8-pin
- 21 - 14-pin
- 45 - 16-pin
- 1 - 18-pin
- 15 - 20-pin
- 1 - 24-pin
- 9 - 28-pin
- 4 - 40-pin



#### CAPACITORS C

- 3 - 47 pF @ C7,8,9
- 1 - 300 pF @ C18
- 65 - 0.1 μF Monolithic @
- 13 - 10 μF/25V Tantalum\* @ C2,3,4,5,6  
 C10,11,12,13,14,15,16,17

\*Match + of Tantalum capacitors with + on the layout  
 1 - 5-50 pF Trimcap @ C1

CRYSTAL Y \*Fold crystal flat against the board before soldering. Solder the case to the two grounding pads  
 1 - 14.31818 MHz @ Y1

#### SWITCHES

- 1 - 8-position DIP @ SW1 for system configuration
- 1 - 8-position DIP @ SW2 for ROM selection
- 1 - 4-position DIP @ SW3 for ROM selection

#### CONNECTORS

- 1 - 1x3 header, male, straight @ JP1
- 1 - 1x4 header, male, 90° @ P3 for speaker
- 1 - 12-pin, male, Molex @ P1 for power
- 8 - 62-pin edge card connectors @ J1,2,3,4,5,6,7,8
- 1 - 5-pin DIN, 90° @ P2 \*Position @ either position PC or XT

#### DELAY LINE

- 1 - 100 ns @ U95 \*Install in socket
- \*Solder directly to the board

#### INTEGRATED CIRCUITS

ICs with pin 1 on the layout

- 1 - 74LS00 @ U85
- 1 - 74LS02 @ U24,97
- 2 - 74LS04 @ U18,67
- 1 - 74LS10 @ U84
- 2 - 74LS20 @ U12,66
- 1 - 74LS27 @ U17
- 1 - 74LS32 @ U50
- 2 - 74LS74 @ U52,82
- 3 - 74LS138 @ U23,51,81
- 2 - 74LS175 @ U27,83
- 6 - 74LS244 @ U6,9,10,11,16,21
- 4 - 74LS245 @ U2,13,14,22
- 1 - 74LS322 @ U53
- 3 - 74LS373 @ U5,7,15
- 1 - 74LS670 @ U26
- 2 - 74S00 @ U96,99
- 2 - 74S08 @ U79,98
- 1 - 74S74 @ U65
- 1 - 74S138 @ U80
- 2 - 74S157 @ U47,64
- 1 - 74S280 @ U25
- 2 - 7404 @ U100,101
- 1 - 7407 @ U19
- 1 - 75477 @ U68
- 1 - 8088 @ U3 MPU
- 1 - 8087 @ U4 (optional)
- 1 - 8237A-5 @ U36
- 1 - 8253-5 @ U49
- 1 - 8255A-5 @ U37
- 1 - 8259A @ U48
- 1 - 8284A @ U1
- 1 - 8288 @ U8
- 9 - 4164 RAM, 200 ns @ BNK 0
- 27 - 4164 RAM (optional) @ BNK1,2,3
- 1 - 2764 EPROM, 200 ns @ U23 BIOS ROM
- 7 - 2764 EPROM (optional) @ U28,29,30,31,32,33,34

EXBM XT SYSTEM MOTHERBOARD (continued)

SWITCH SW1 SETTINGS: SYSTEM CONFIGURATION

SWITCH #	1	2	3	4	5	6	7	8
OPERATING MODE	normal	8087	RAM	monitor	drive #			
	off	no 8087 with 8087	128K 192K 256K	off on on off off off	none 40x25 colour 80x25 colour monochrome	on on on on on off off off	1 2 3 4	on on off on on off off off

EPROM SELECTION SW2,3 - LOCATION OF MEMORY DECODER (U23 74LS138)

		EPROM/ROM SELECTION								LOCATION OF U23					
		SW2				SW3				note position of pin 1 on layout					
switch no		1	2	3	4	5	6	7	8	9	10	11	12		
2764 EPROM	on	off	on	off	on	off	on	off	on	off	on	off	on	A	
27128 EPROM	on	off	off	on	on	off	on	off	on	off	off	off	on	B	
8Kx8 ROM	on	off	on	off	off	on	off	on	off	on	off	off	on	A	
32Kx8 ROM	off	on	off	on	on	off	on	off	on	off	on	off	on	C	

# GUIDE XT-5

**PRESTIGE I XT:** Features include: 8088 MPU with socket for optional 8087 co-processor; seven I/O expansion slots; PC spacing of 25 mm; on-board memory in blocks of 64 K to a maximum of 256 K using 4164 or equivalent RAM chips; eight ROM sockets. Documentation and schematics are available from supplier. Requires modification.

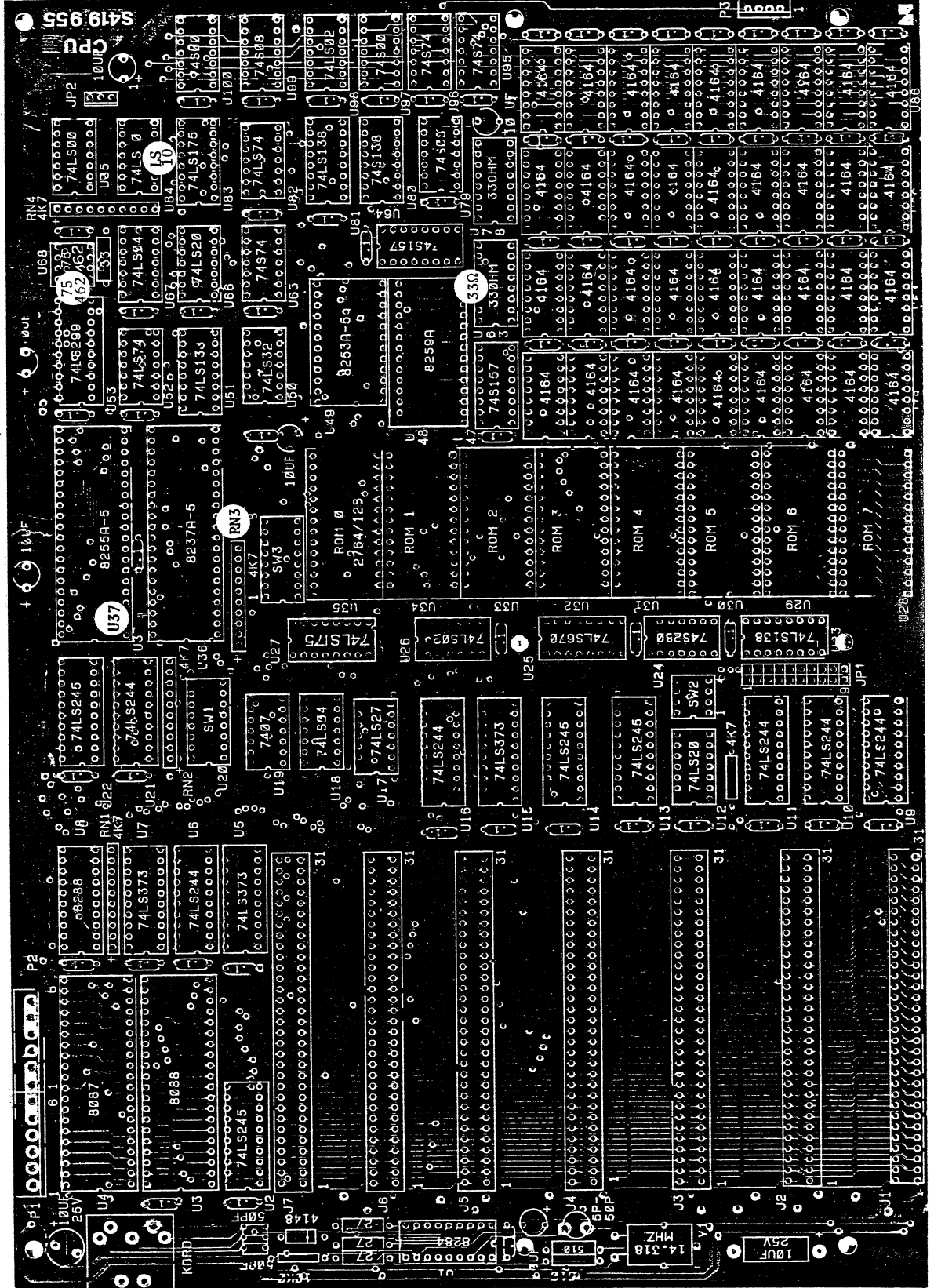

actual size  
30.3 x 21.6 cm  
(layout is  
reduced)

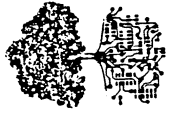

NuScope Associates

PRESTIGE I XT MOTHERBOARD (cont)

DIODE D \*Position banded (cathode) end of diode towards the square  
 1 - 1N4148 @ 4148

RESISTORS R ¼ watt, 5%  
 3 - 27 Ω  
 1 - 33 Ω  
 2 - 510 Ω  
 1 - 4.7 KΩ  
 1 - 10 KΩ  
 4 - 4.7 KΩ 10-pin SIP @ RN1,2,3,4  
 \*Match pin 1 of SIPs with pin 1 (+) on the layout  
 2 - 33 Ω 16-pin DIP @ U63,78  
 \*Solder directly to the board  
 \*Sixteen 33 Ω resistors may be substituted at U63,78

SOCKETS \*Match pin 1 of sockets with pin 1 on the layout. Check that ALL pins have passed thru ALL holes

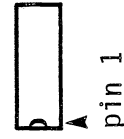

21 - 14-pin  
 47 - 16-pin  
 1 - 18-pin  
 15 - 20-pin  
 1 - 24-pin  
 9 - 28-pin  
 4 - 40-pin

CAPACITORS C  
 3 - 50 pF  
 75 - 0.1 μF Monolithic @ .1  
 1 - 5-50 pF Trimcap  
 \*Match + of the following caps with + on the layout  
 1 - 10 μF/25V Axial\*  
 7 - 10 μF/25V Tantalum\* @ +

CRYSTAL \*Fold crystal flat against the board before soldering. Solder the case to the grounding pads  
 1 - 14.31818 MHz @ Y1

SUGGESTED SEQUENCE \*INDICATES A PRECAUTION

SWITCHES SW  
 1 - 4-position DIP @ SW2  
 1 - 8-position DIP @ SW1,3

CONNECTORS  
 1 - 2x9 header, male, straight @ JPI  
 1 - 1x3 header, male, straight @ JP2  
 1 - 1x4 header, male, straight @ P3  
 1 - 12-pin power connector @ P1,P2  
 8 - 62-pin card-edge connectors @ J1,2,3,4,5,6,7,8  
 1 - 5-pin DIN keyboard connector @ KBRD

POWER PINOUT pin # for

P1: 1 power good  
 2 key  
 3 +12  
 4 -12  
 5,6 GND

P2: 1,2 GND  
 3 -5  
 4,5,6 +5

\*MODIFICATION REQUIRED

INTEGRATED CIRCUITS \*Match pin 1 of IC with pin 1 on the layout

1 - 74LS00 @ U85  
 2 - 74LS02 @ U26,98  
 2 - 74LS04 @ U18,67  
 1 - 74LS08 @ U99  
 1 - 74LS10 @ U84  
 2 - 74LS20 @ U12,66  
 1 - 74LS27 @ U17  
 1 - 74LS32 @ U50  
 2 - 74LS74 @ U52,82  
 3 - 74LS138 @ U23,51,81  
 2 - 74LS175 @ U27,83  
 6 - 74LS244 @ U6,9,10,11,16,21  
 4 - 74LS245 @ U2,13,14,22  
 1 - 74LS299 @ U53  
 3 - 74LS373 @ U5,7,15  
 1 - 74LS670 @ U25

2 - 74S00 @ U97,100  
 1 - 74S08 @ U79  
 3 - 74S74 @ U65,95,96  
 1 - 74S138 @ U80  
 2 - 74S157 @ U47,64  
 1 - 74S280 @ U24

1 - 7407 @ U19  
 1 - 75462 @ U68

1 - 8088 @ U3 MPU  
 1 - 8087 @ U4 (optional)  
 1 - 8237A-5 @ U36  
 1 - 8253-5 @ U49  
 1 - 8255A-5 @ U37  
 1 - 8259A @ U48  
 1 - 8284A @ U1  
 1 - 8288 @ U8

18 - 4164 DRAM 150 ns standard @ U38-46 & U54-62  
 18 - 4164 DRAM 150 ns (optional) @ U69-77 & U86-94  
 1 - 2764 Boot EPROM 250 ns @ U35  
 7 - 2764 EPROMs 250 ns @ U28,29,30,31,32,33,34

PRESTIGE I XT MOTHERBOARD (continued)

SWITCH SW1 SETTINGS: SYSTEM CONFIGURATION

SWITCH #	1	2	3	4	5	6	7	8
OPERATING MODE	normal	8087	RAM	monitor	drive #			
	off	no 8087 with 8087	128K	none	1	on	on	on
	off	off	192K	40x25 colour	2	off	off	off
			256K	80x25 colour	3	on	on	off
				monochrome	4	off	off	off

ROM BIOS DECODER (SW2, SW3, and JP1)

		EPROM/ROM SELECTION							
		SW3							
		SW2				SW2			
switch no		1	2	3	4	5	6	7	8
2764 EPROM	on	off	on	off	on	off	on	off	on
27128 EPROM	on	off	off	on	on	off	on	off	on
8Kx8 ROM	on	off	on	off	on	off	on	off	on
32Kx8 ROM	off	on	off	on	on	off	on	off	on

For 2764 EPROM or 8K x 8 ROM strap across 1,2,3 @ JP1

MODIFICATION ON THE SOLDER SIDE

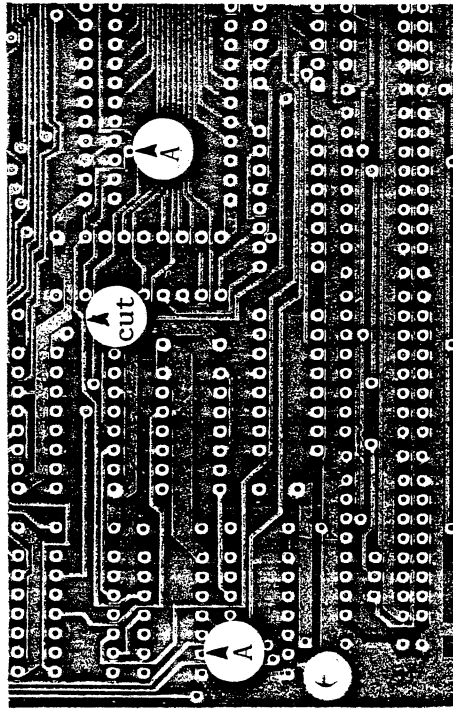

(U97)

CUT as shown  
STRAP A to A

GUIDE XT-6

**SUPER XT MOTHERBOARD:** Features include: 8088 MPU with socket for optional 8087 co-processor; eight I/O expansion slots, XT spacing of 20 mm; on-board memory in blocks of 64 K to a maximum of 256 K using 4164 or equivalent RAM chips; eight ROM sockets; documentaion and schematics available from supplier.

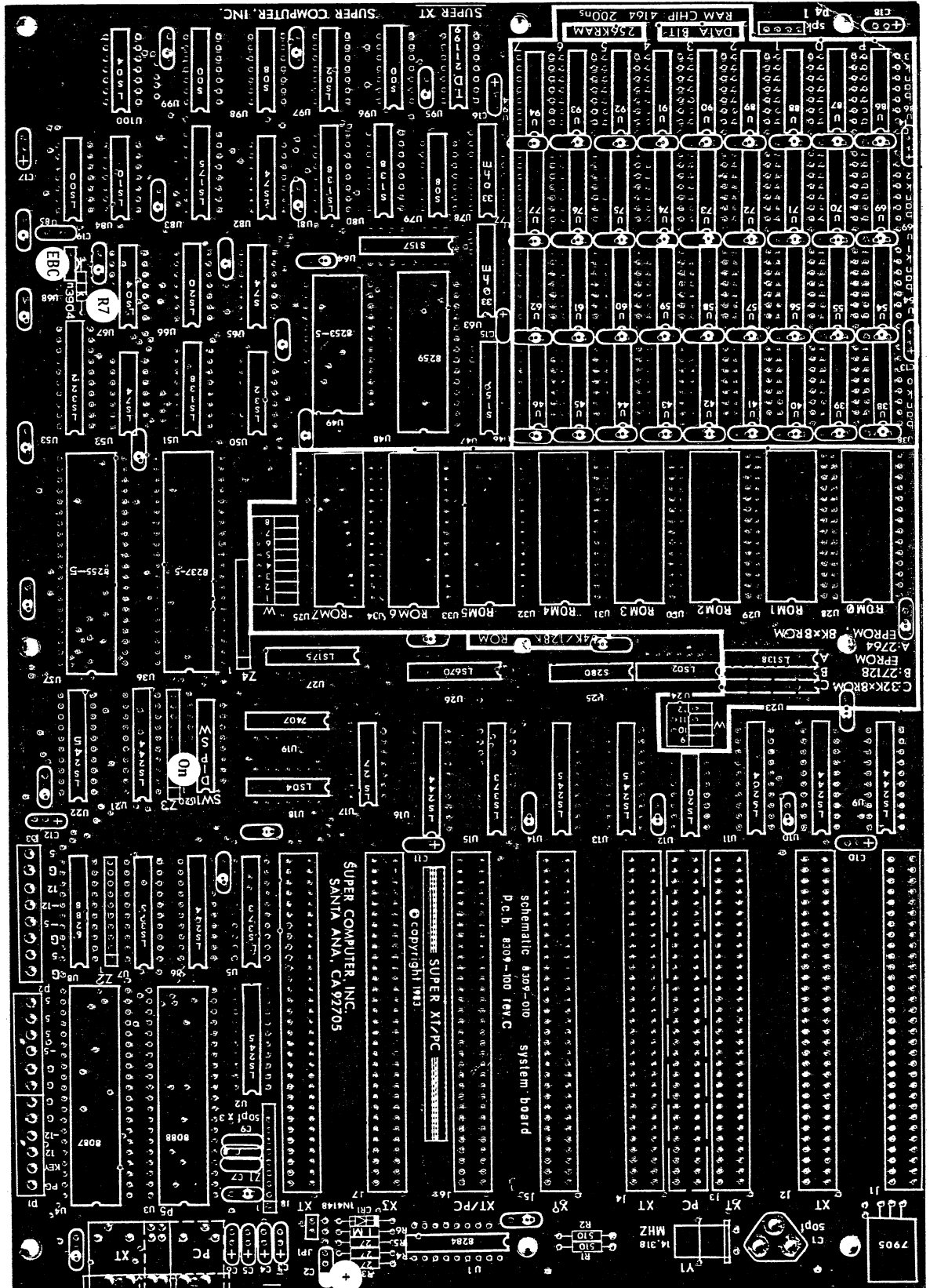

actual size  
30.3 cm x 21.6 cm  
(layout is reduced)

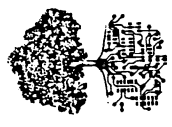

NuScope Associates

**SUPER XT MOTHERBOARD (continued)**

DIODE, D \*Position banded (cathode) end of diode towards the arrow  
 1 - 1N4148 @ CR1

RESISTORS R ¼ watt, 5%  
 3 - 27 Ω @ R3,4,5  
 2 - 510 Ω @ R1,2  
 1 - 1 KΩ @ R7  
 1 - 1 MΩ @ R6  
 4 - 4.7 KΩ 10-pin SIP\* @ Z1,2,3,4

\*Match pin 1 of SIPs with pin 1 on the layout  
 2 - 33 Ω 16-pin DIP\* @ U63,78  
 \*Solder directly to the board  
 \*Sixteen 33 Ω resistors may be substituted

SOCKETS \*Match pin 1 of sockets with pin 1 on the layout. Check that ALL pins have passed thru ALL holes  
 20 - 14-pin  
 47 - 16-pin  
 1 - 18-pin  
 15 - 20-pin  
 1 - 24-pin  
 9 - 28-pin  
 4 - 40-pin

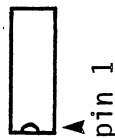

CAPACITORS C  
 3 - 50 pF  
 1 - 0.01 μF @ C19  
 63 - 0.1 μF Monolithic\* @   
 \*Note TWO different spacings between solder pads.  
 Select CORRECT PADS.

14 - 10 μF/25V Tantalum\* @ C2,3,4, C5,6,10,11,12,13,14,15,16, C17,18 \*Match + of caps with + on the layout  
 1 - 5-50 pF Trimap @ C1

TRANSISTOR Q \*Position EBC leads as shown  
 1 - 2N3904 @ n3904

**SUGGESTED SEQUENCE \*INDICATES A PRECAUTION**

CRYSTAL Y \*Fold crystal flat against the board before soldering. Solder the case to the grounding pads at sides  
 1 - 14.31818 MHz @ Y1

SWITCHES  
 1 - 8-position DIP @ SW1 selects system configuration  
 \*The following TWO switches (W) select EPROM/ROM type. Install one 74LS138 IC at A,B, or C of U23 accordingly  
 1 - 8-position DIP @ W1 to W8  
 1 - 4-position DIP @ W9 to W12

CONNECTORS  
 1 - 1x3 header, male, straight @ JP1  
 1 - 1x4 header, male, straight @ P4  
 1 - 12-pin power connector @ P1,P2  
 1 - 6-pin power connector @ P3  
 \*for Apple-type power supply  
 8 - 62-pin card edge connectors @ J1,2,3,4,5,6,7,8  
 1 - 5-pin DIN keyboard connector @ PC or XT

DELAY LINE  
 1 - 100 ns @ U95. Solder to the board  
 VOLTAGE REGULATOR \*Install only if power supply lacks -5 V  
 1 - 7905 5V negative regulator

INTEGRATED CIRCUITS \*Match pin 1 of ICs with pin 1 on the layout  
 1 - 74LS00 @ U85  
 2 - 74LS02 @ U24,97  
 3 - 74LS04 @ U18.67,100  
 1 - 74LS10 @ U84  
 2 - 74LS20 @ U12,66  
 1 - 74LS27 @ U17  
 1 - 74LS32 @ U50  
 2 - 74LS74 @ U52,82  
 3 - 74LS138 @ U23,51,81  
 2 - 74LS175 @ U27,83  
 6 - 74LS244 @ U6,9,10,11,16,21  
 4 - 74LS245 @ U2,13,14,22  
 1 - 74LS322 @ U53  
 3 - 74LS373 @ U5,7,15  
 1 - 74LS670 @ U26

2 - 74S00 @ U96,99  
 2 - 74S08 @ U79,98  
 1 - 74S74 @ U65  
 1 - 74S138 @ U80  
 2 - 74S157 @ U47,64  
 1 - 74S280 @ U25  
 1 - 7407 @ U19  
 1 - 8088 @ U3 MPU  
 1 - 8087 @ U4 (optional)  
 1 - 8237A-5 @ U36  
 1 - 8253-5 @ U49  
 1 - 8255A-5 @ U37  
 1 - 8259A @ U48  
 1 - 8284A @ U1  
 1 - 8288 @ U8

18 - 4164 DRAM 200 ns (standard) @ bank 0 & bank 1  
 18 - 4164 DRAM 200 ns (optional) @ bank 2 & bank 3  
 1 - 2764 Boot EPROM 250ns @ ROM 7  
 7 - 2764 EPROM (optional) @ ROM 0,1,2,3,4,5,6



SUPER XT MOTHERBOARD: (continued)

SWITCH SW1 SETTINGS: SYSTEM CONFIGURATION

SWITCH #	1	2	3	4	5	6	7	8
OPERATING MODE	normal	8087	RAM	monitor	drive #			
	off	no 8087 with 8087	128K 192K 256K	off on on off off off	on on on off on off	1 2 3 4	on off on off	on on off off

EPROM/ROM SELECTION (SWITCHES W): LOCATION OF MEMORY DECODER (U23, 74LS138)

W number	EPROM/ROM SELECTION								LOCATION OF U23				
	W - near ROM 7				W - near U12								
2764 EPROM	1	2	3	4	5	6	7	8	9	10	11	12	position
27128 EPROM	on	off	on	off	on	off	on	off	off	on	off	on	A
8Kx8 ROM	on	off	on	off	on	off	on	off	off	on	off	on	B
32Kx8 ROM	off	on	off	on	off	on	off	on	on	off	on	off	A
									on	off	on	off	C

# GUIDE XT-7

ECS-7 GRANDE MOTHERBOARD: Features include: 8088 MPU with socket for optional 8087 co-processor; eight I/O expansion slots, XT spacing of 20 mm (J1 allows for bus expansion via a 2 x 31 header); on board memory in blocks of 64 K to a maximum of 256 K using 4164 or equivalent chips, or to a maximum of 1 M using 256 K RAM chips; five ROM sockets jumper programmable to accept 8,16,32,64 K ROM or EEPROM ICs; hardware reset switch; wire-wrap area.

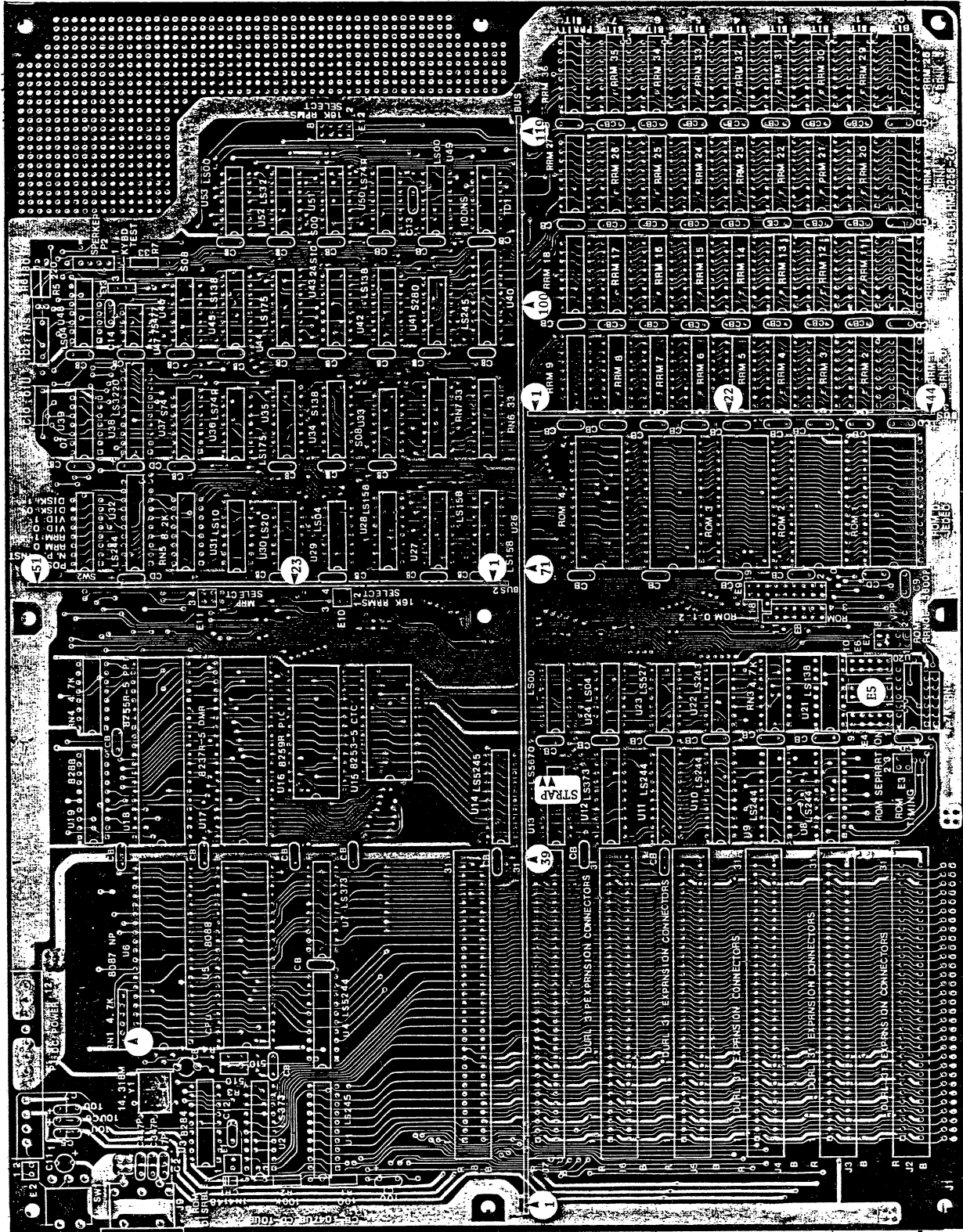

actual size  
344 x 268 mm  
(layout is reduced)

\*Not ALL bus  
bar pins are  
shown!



NuScope Associates

ECS-7 GRANDE MOTHERBOARD (continued)

SUGGESTED SEQUENCE \*INDICATES A PRECAUTION \*MODIFICATION REQUIRED

\*MODIFICATION ON THE SOLDER SIDE  
 Strap pin 9 of U13 to the feed-thru hole directly below as shown on the layout. Altho the mod is shown on the COMPONENT SIDE, the strapping should be done on the SOLDER SIDE.

Use the bare board as a guide to prepare the three bus bars. Install later.

DIODE D \*Position banded (cathode) end of diode as shown  
 1 - 1N4148 @ CR1

RESISTORS R 1/4 watt, 5%  
 1 - 33 Ω @ R7  
 1 - 100 Ω @ R1  
 1 - 180 Ω @ R6  
 1 - 220 Ω @ R5  
 2 - 510 Ω @ R3,4  
 1 - 100 KΩ R2  
 2 - 4.7 KΩ 6-pin SIP\* @ RN1,2  
 \*Match pin 1 of SIPs with pin 1 on the layout.

\*Solder the following DIP resistor networks to the board. Single resistors may be substituted - solder these directly to the board

2 - 330 Ω 16-pin DIP @ RN6,7  
 2 - 4.7 KΩ 16-pin DIP @ RN3,4  
 1 - 8.2 KΩ 16-pin DIP @ RN5

SOCKETS #Match pin 1 of sockets with pin 1 (square pad) on the layout. Check that ALL pins have passed thru ALL holes before soldering

1 - 8-pin  
 21 - 14-pin

SOCKETS (continued)  
 53 - 16-pin  
 1 - 18-pin  
 14 - 20-pin  
 1 - 24-pin  
 6 - 28-pin  
 4 - 40-pin

CAPACITORS C  
 3 - 47 pF Monolithic @ C2,3,4  
 1 - 100 pF Monolithic @ C13  
 1 - 5600 pF Monolithic @ C9  
 1 - 0.01 μF Mylar, Axial @ C10  
 1 - 0.1 μF Monolithic @ C12,14,CB  
 10 μF/16V Tantalum\* @ C1,5,6,7,11 and positions CD \*Match + with + on the layout

CRYSTAL Y \*Fold crystal flat against the board before soldering. Solder the case to the grounding pads  
 1 - 14.31818 MHz @ Y1

SWITCH  
 1 - Minature PB, momentary contact @ SW1  
 1 - 8-position DIP @ SW2

BUS BARS ten pins per inch Prepare in the following manner: Cut bus bars to length. Mark pins to be used with a felt pen. Remove unused pins with needlenosed pliers. Check that tabs are cleanly removed & cannot cause shorts with bus bar installed. Install & solder.

BUS 1 - 30 cm. Use pins 1,7,10,19,39,51,59,71,83,87,88,100,107,119  
 BUS 2 - 12.9 cm. Use pins 1,7,17,23,39,51  
 BUS 3 - 11.1 cm. Use pins 1,2,4,10,22,28,32,36,40,44

HEADERS All are male straight  
 2 - 1x2 pins @ E2,3  
 3 - 2x5 pins @ E4,5,6  
 1 - 2x4 pins @ E7  
 1 - 2x7 pins @ E8 NON-STANDARD\* remove pin 14 before installing  
 1 - 2x9 pins @ E9 NON-STANDARD\* add one pin at 13

CONNECTORS  
 1 - 12-pin Molex @ P1 PINOUT FOR POWER

pin for reset  
 1  
 2 key +12  
 3 -12  
 4 GND  
 5,6,7,8 -5  
 10,11,12 +5

1 - 5-pin DIN, 90°  
 7 - 62-pin card edge-connectors  
 1 - 2x31 header, male, straight @ J1 for bus expansion

DELAY LINE \*Solder directly to the board  
 1 - 100 ns digital @ TD1 in socket  
 1 - 7 ns inductive @ TD2\*  
 \*TD2 required only for 256 K RAM chips. Otherwise substitute a 150 Ω resistor and a 56 pF cap as shown below



TD2 7NS  
 150 Ω  
 56 pF

1-15026 (648 pages)

ECS-7 GRANDE MOTHERBOARD (continued)

INTEGRATED CIRCUITS \*Match pin 1 of ICs with pin 1 on the layout

3 - 74LS00	@ U25,49,53
3 - 74LS04	@ U24,29,48
1 - 74LS10	@ U31
1 - 74LS20	@ U30
1 - 74LS27	@ U23
1 - 74LS30	@ U20
1 - 74LS32	@ U52
2 - 74LS74	@ U36,50
3 - 74LS138	@ U21,42,45
3 - 74LS158	@ U26,27,28†
2 - 74LS175	@ U35,44
1 - 74LS243	@ U22
6 - 74LS244	@ U4,8,9,10,11,32
3 - 74LS245	@ U1,14,40
1 - 74LS322A	@ U38
3 - 74LS373	@ U2,7,12
1 - 74LS670	@ U13
1 - 74S00	@ U51
2 - 74S08	@ U33,46
1 - 74S74	@ U37
1 - 74S138	@ U34
1 - 74S280	@ U41
1 - 7407	@ U39
1 - 75477	@ U47
1 - 8087	@ U6 (optional)
1 - 8088	@ U5 MPU
1 - 8237A-5	@ U17
1 - 8253-5	@ U15
1 - 8255A-5	@ U18
1 - 8259A	@ U16
1 - 8284	@ U3
1 - 8288	@ U19

STRAPPING (continued)

FOR 64 K DRAM  
E10,11,12 not equipped  
FOR KEYBOARD TEST  
E13 not equipped

ROMs:

Location starting address	function
ROM 0	F600 4th BASIC ROM
ROM 1	F800 3rd BASIC ROM
ROM 2	FA00 2nd BASIC ROM
ROM 3	FE00 1st BASIC ROM
ROM 4	FE00 boot ROM

STRAPPING Refer to documentation for a detailed description

\*Terminal numbering on E8 & E9 is non-standard, especially terminals 13,14,15  
FOR ROM DISABLE:

E1 not equipped

FOR POWER RESET

E2 equip only if power supply provides pin 1 reset

FOR 64 K EPROMs (2764)

Location strap

E3 1-2

E4,5,6 7-8

E7 3-4

E8 5-6

1-3 7-8

5-6 8-10

11-12 1-2

E9 5-7

10-12

14-15

18-19

SWITCH SW2 SETTINGS: SYSTEM CONFIGURATION

SWITCH #	1	2	3	4	5	6	7	8
OPERATING MODE	normal	off	RAM	128K	off	on	monitor	none
	off	no 8087	192K	on	off	on	40x25 colour	on
		with 8087	256K	off	off	on	80x25 colour	on
				off	off	off	monochrome	off
							drive #	
							1	on
							2	off
							3	on
							4	off

† Equip U28 only when using 256 K RAM chips

GUIDE XT-8

**PRESTIGE II XT MOTHERBOARD:** Features include: 8088 MPU with socket for optional 8087 co-processor; eight expansion slots, XT spacing of 20 mm; on-board memory in blocks of 64 K to a maximum of 256 K using 4164 or equivalent RAM chips; eight ROM sockets. Documentation and schematics are available from supplier. Modification required.

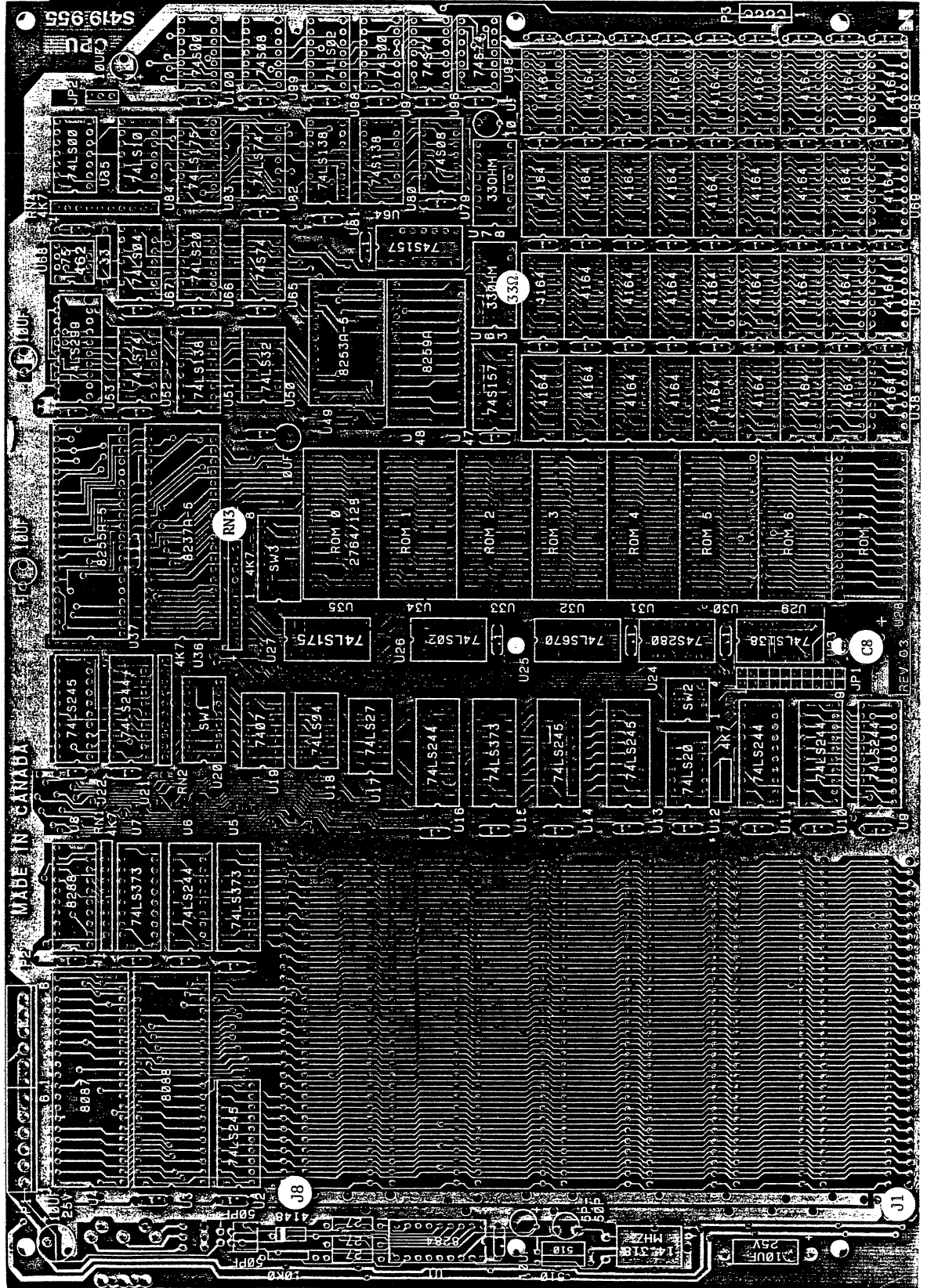

actual size  
30.3 x 21.6 cm  
(layout is  
reduced)

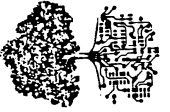

PRESTIGE II XT MOTHERBOARD (cont)

DIODE D \*Position banded (cathode) end of diode towards the square  
 1 - 1N4148 @ 4148

RESISTORS R 1/4 watt, 5%  
 3 - 27 Ω  
 1 - 33 Ω  
 2 - 510 Ω  
 1 - 4.7 KΩ  
 1 - 10 KΩ  
 4 - 4.7 KΩ 10-pin SIP @ RN1,2,3,4  
 \*Match pin 1 of SIPs with pin 1 (+) on the layout

2 - 33 Ω 16-pin DIP @ U63,78  
 \*Solder directly to the board  
 \*Sixteen 33 Ω resistors may be substituted at U63,78

SOCKETS \*Match pin 1 of sockets with pin 1 on the layout. Check that ALL pins have passed thru ALL holes

- 21 - 14-pin
- 47 - 16-pin
- 1 - 18-pin
- 15 - 20-pin
- 1 - 24-pin
- 9 - 28-pin
- 4 - 40-pin



CAPACITORS C

3 - 50 pF  
 75 - 0.1 μF Monolithic @ .1  
 1 - 5-50 pF Trimcap

\*Match + of the following caps with + on the layout

- 1 - 10 μF/25V Axial\*
- 8 - 10 μF/25V Tantalum\* @ + ○ and R8

CRYSTAL \*Fold crystal flat against the board before soldering. Solder the case to the grounding pads  
 1 - 14.31818 MHz @ Y1

SUGGESTED SEQUENCE \*INDICATES A PRECAUTION

SWITCHES SW  
 1 - 4-position DIP @ SW2  
 1 - 8-position DIP @ SW1,3

CONNECTORS

1 - 2x9 header, male, straight @ JP1  
 1 - 1x3 header, male, straight @ JP2  
 1 - 1x4 header, male, straight @ P3  
 1 - 12-pin power connector @ P1,P2  
 8 - 62-pin card-edge connectors @ J1,2,3,4,5,6,7,8  
 1 - 5-pin DIN Keyboard connector @ KBRD

POWER PINOUT pin # for

P1 1 power good  
 2 key  
 3 +12  
 4 -12  
 5,6 GND  
 P2 1,2 GND  
 3 -5  
 4,5,6 +5

\*MODIFICATION REQUIRED

INTEGRATED CIRCUITS \*Match pin 1 of IC with pin 1 on the layout

- 1 - 74LS00 @ U85
- 2 - 74LS02 @ U26,98
- 2 - 74LS04 @ U18,67
- 1 - 74LS08 @ U99
- 1 - 74LS10 @ U84
- 2 - 74LS20 @ U12,66
- 1 - 74LS27 @ U17
- 1 - 74LS32 @ U50
- 2 - 74LS74 @ U52,82
- 3 - 74LS138 @ U23,51,81
- 2 - 74LS175 @ U27,83
- 6 - 74LS244 @ U6,9,10,11,16,21
- 4 - 74LS245 @ U2,13,14,22
- 1 - 74LS299 @ U53
- 3 - 74LS373 @ U5,7,15
- 1 - 74LS670 @ U25
- 2 - 74S00 @ U97,100
- 1 - 74S08 @ U79
- 3 - 74S74 @ U65,95,96
- 1 - 74S138 @ U80
- 2 - 74S157 @ U47,64
- 1 - 74S280 @ U24
- 1 - 7407 @ U19
- 1 - 75462 @ U68
- 1 - 8088 @ U3 MPU
- 1 - 8087 @ U4 (optional)
- 1 - 8237A-5 @ U36
- 1 - 8253-5 @ U49
- 1 - 8255A-5 @ U37
- 1 - 8259A @ U48
- 1 - 8284A @ U1
- 1 - 8288 @ U8
- 18 - 4164 DRAM 150 ns standard @ U38-46 & U54-62
- 18 - 4164 DRAM 150 ns (optional) @ U69-77 & U86-94
- 1 - 2764 Boot EPROM 250 ns @ U35
- 7 - 2764 EPROMs 250 ns @ U28,29,30,31,32,33,34

PRESTIGE II XT MOTHERBOARD (continued)

SWITCH SW1 SETTINGS: SYSTEM CONFIGURATION

SWITCH #	1	2	3	4	5	6	7	8														
OPERATING MODE	normal	off	no 8087 with 8087	on	off	on	128K	192K	256K	RAM	monitor	drive #	1	2	3	4	on	off	on	off	on	off

ROM BIOS DECODER (SW2, SW3, and JP1)

switch no	EPROM/ROM SELECTION											
	SW3				SW2							
2764 EPROM	1	2	3	4	5	6	7	8	1	2	3	4
27128 EPROM	on	off	on	off	on	off	on	off	off	on	off	on
8Kx8 ROM	on	off	on	off	on	off	on	off	on	off	on	off
32Kx8 ROM	off	on	off	on	off	on	off	on	on	off	on	off

For 2764 EPROM or 8K x 8 ROM strap across 1,2,3 @ JP1

MODIFICATION ON THE SOLDER SIDE

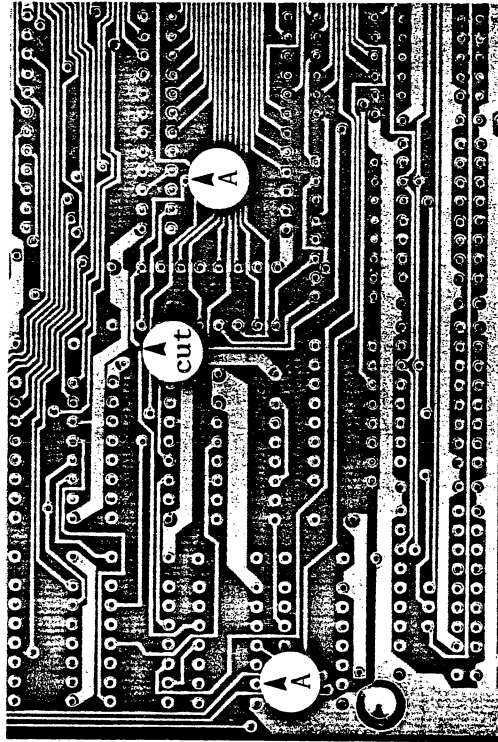

(U97)

CUT as shown  
STRAP A to A



NuScope Associates

GUIDE 2-1

RHE DISK CONTROLLER CARD: Allows user to run up to four 5¼" floppy disk drives. With power off, install in any available slot. Requires firmware (one PROM). To run 8" drives, extra devices are required (not shown). Position DIP switch on motherboard according to the number of drives in use. Schematics are available from supplier.

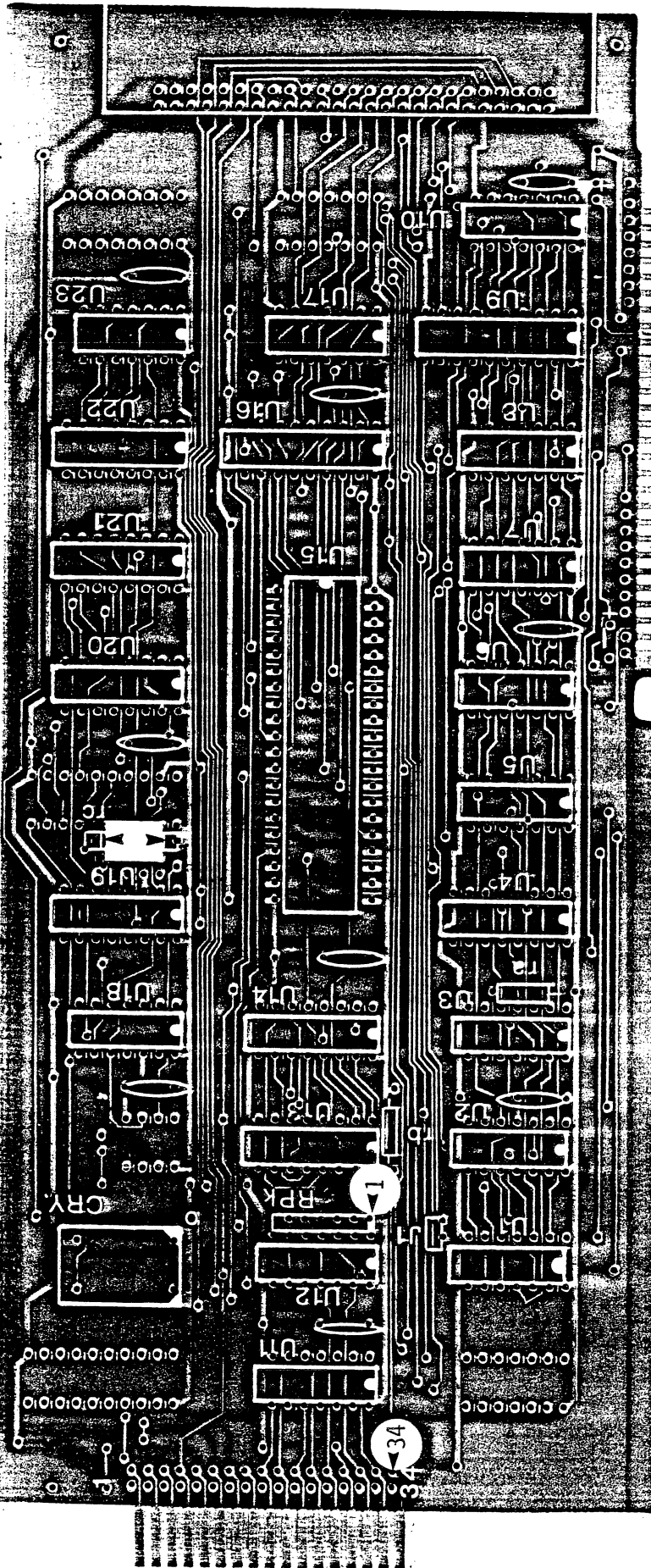

SUGGESTED SEQUENCE \*INDICATES A PRECAUTION

- RESISTORS R ¼ watt 5%  
 1 - 150 Ω @ Rb  
 1 - 4.7 KΩ @ Ra  
 1 - 4.7 KΩ @ Rc  
 as shown on the layout  
 1 - 1 KΩ 6-pin SIP @ RPK \*Match  
 pin 1 of SIP with pin 1 on the layout

Actual size is 24.2 x 10.8 cm.

- SOCKETS \*Match pin 1 of sockets with pin 1 CAPACITORS C  
 on the layout. Check that ALL pins  
 have passed thru ALL holes

- 13 - 14-pin  
 7 - 16-pin  
 2 - 20-pin  
 1 - 40-pin

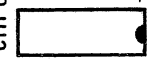

- 9 - 0.1 μF Monolithic @ positions 0  
 2 - 10 μF/25V Radial @ positions  
 \*Match + of Radials  
 with + on layout

OSCILLATOR (crystal)

- 1 - 16.0000 MHz @ CRY

RHE DISK CONTROLLER CARD (CONTINUED)

CONNECTORS

- 1 - 2-pin header, male, straight @ J1
- 1 - Jumper plug - install @ J1 for 5¼" drive operation
- 1 - rear panel adaptor

INTEGRATED CIRCUITS \*Match pin 1 of ICs with pin 1 on the layout

- 1 - 74LS00 @ U1
- 3 - 74LS04 @ U10,12,23
- 1 - 74LS08 @ U5
- 1 - 74LS30 @ U7
- 2 - 74LS32 @ U2,6
- 1 - 74LS74 @ U3

INTEGRATED CIRCUITS (continued)

- 1 - 74LS126 @ U8
  - 1 - 74LS139 @ U22
  - 1 - 74LS153 @ U20
  - 1 - 74LS163 @ U19
  - 1 - 74LS174 @ U14
  - 2 - 74LS175 @ U4,21
  - 1 - 74LS245 @ U9
  - 1 - 74LS273 @ U16
  - 1 - 74LS393 @ U18
  - 1 - 7406 @ U11
  - 1 - 7438 @ U17
  - 1 - 765 (NEC) or 8272 (INTEL) @ U15
  - 1 - 82S123 PROM @ U13
- \*S ICs can be substituted for LS ICs

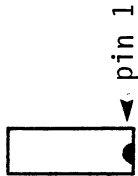

THE FOLLOWING CARD IS IDENTICAL EXCEPT FOR THE SILK-SCREENING. Use the preceding parts list. Delete components labelled "D".

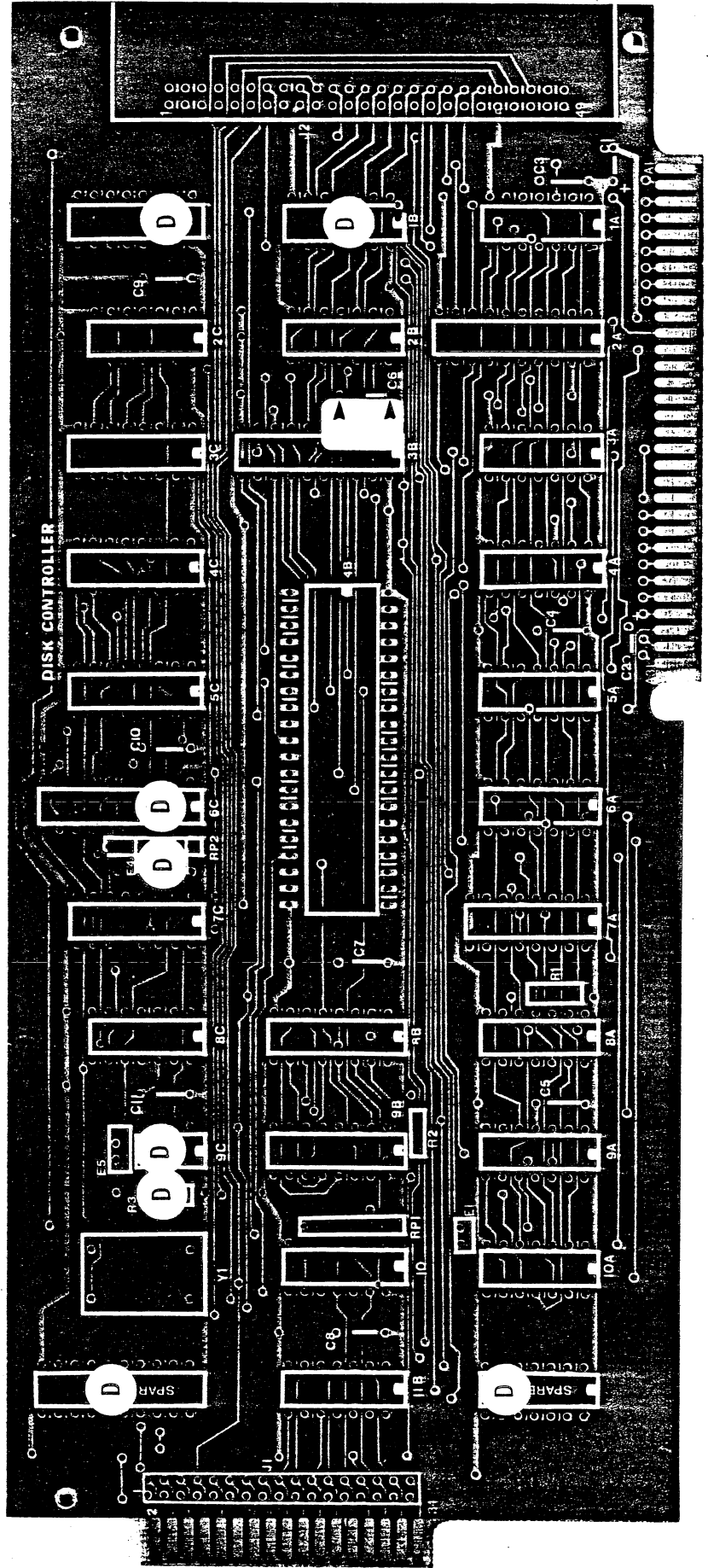

RHE DISK CONTROLLER CARD (continued):

USING THE CARD:

The RHE Disk Controller Card does not use the same disk select scheme as IBM. IBM uses a twist in the ribbon cable connecting the drives to the controller to select between drives. On the other hand, the RHE uses a more conventional approach of using jumpers on the drive to do drive select. IBM has a separate line for "motor select" while the RHE uses "drive select" to turn the motor on. Since "drive select" is gated by "motor select", the operation of the drive motor is identical for both the RHE and the IBM disk controller.

\*If no drives are selected by a DS#, then none will run.  
 \*If two are selected by the same DS# then erratic operation or damage may result.

IBM PC  
 Wires 10-16  
 Twisted on Drive A

1) TANDON 1/2 HEIGHT

1----16 HS In  
 2----15 DSO  
 3----14 DS1  
 4----13 DS2  
 5----12 DS3  
 6----11 MUX OUT  
 8----9 HM IN

2) TEAC 1/2 HEIGHT

DSO  
 DS1  
 DS2  
 DS3  
 MX OUT  
 MS IN  
 ST IN  
 WT OUT

2) SHUGART 1/2 HEIGHT

DS1  
 DS2  
 DS3  
 DS4  
 MX OUT  
 MS IN

3) PANASONIC 1/2 HEIGHT

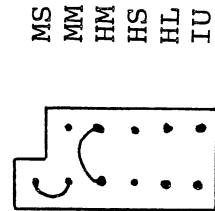
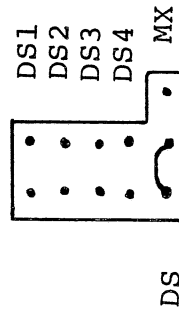



NuScope Associates

GUIDE 2-2

PG DISK CONTROLLER CARD: Allows user to run up to four 5¼" floppy disk drives. With power off, install in any available slot. Position DIP switch on motherboard according to the number of disk drives in use.

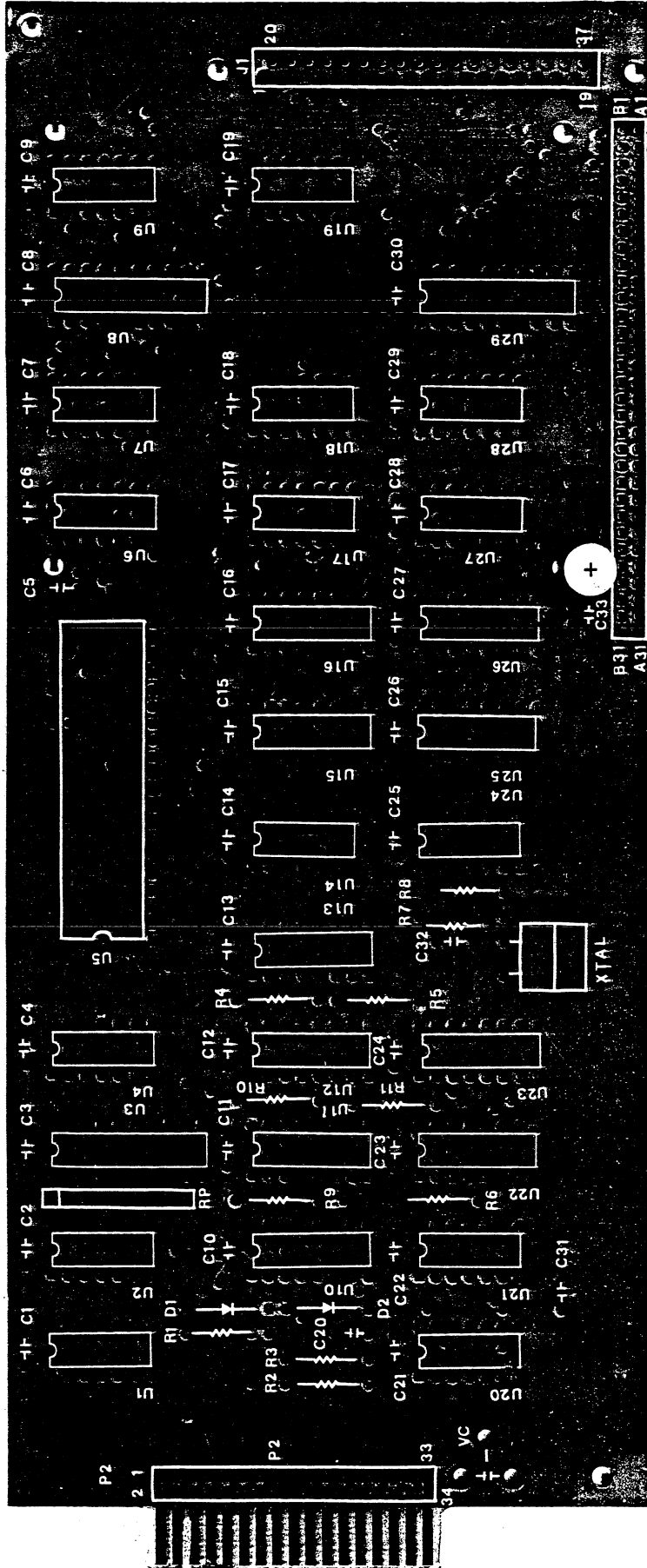

Actual size is 23.8 x 10.6 cm

SUGGESTED SEQUENCE \*INDICATES A PRECAUTION \*MODIFICATION MAY BE REQUIRED

- DIODES D (cathode) as shown  
 2 - 1N914 or 1N4148 @ D1,2  
 ●→ cathode end
- RESISTORS R ¼ watt, 5%  
 2 - 330 Ω @ R7,8  
 1 - 470 Ω @ R1  
 4 - 1 KΩ @ R2,4,9,11  
 3 - 1.8 KΩ @ R5,6,10  
 1 - 3.3 KΩ @ R3

RESISTORS (continued)

- 1 - 1 KΩ SIP\*, 9-pin @ RP  
 \*Match pin 1 of SIP with pin 1 (square) on the layout
- SOCKETS \*Match pin 1 of sockets with pin 1 on the layout. Check that ALL pins have passed thru ALL holes
- 16 - 14-pin pin 1
  - 9 - 16-pin
  - 3 - 20-pin
  - 1 - 40-pin

CAPACITORS C \*Delete VC \*See MOD.

- 1 - 82 pF @ C31
  - 1 - 0.001 μF @ C32
  - 30 - 0.1 μF Monolithic @ C1 to 30
  - 1 - 47 μF/16V Radial\* @ C33
- \*Match + of Radial with + on the layout

PG DISK CONTROLLER CARD (continued)

CRYSTAL Y \*Fold crystal flat against the card before soldering

- 1 - 16.588 Mhz @ XTAL

ADAPTER

- 1 - rear panel adapter

INTEGRATED CIRCUITS \*Match pin 1 of ICs with pin 1 on the layout

- 1 - 74LS02 @ U28
- 1 - 74LS04 @ U18
- 3 - 74LS08 @ U4, 7, 17
- 1 - 74LS09 @ U13
- 1 - 74LS30 @ U27
- 1 - 74LS32 @ U6
- 4 - 74LS38 @ U1, 2, 9, 19
- 1 - 74LS93 @ U14
- 2 - 74LS112 @ U11, 12
- 2 - 74LS153 @ U22, 25
- 1 - 74LS161 @ U23
- 2 - 74LS175 @ U15, 16
- 1 - 74LS191 @ U10
- 1 - 74LS240 @ U3
- 1 - 74LS245 @ U29
- 1 - 74LS273 @ U8
- 1 - D765 @ U5
- 1 - MC4044 @ U20
- 1 - MC4024 @ U21
- 1 - 7404 @ U24
- 1 - MC3487 @ U26

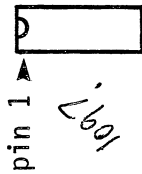

\*MODIFICATION MAY BE REQUIRED

Drives may not run as 82 pF capacitor @ C31 is critical. REPLACE 82 pF with a 47 pF cap AND:

- a) ON COMPONENT SIDE: install one 5-50 pF trimcap @ VC;
  - b) ON SOLDER SIDE: strap A to A, and B to B, as shown on the layout
- Adjust trimcap @ VC until drives run

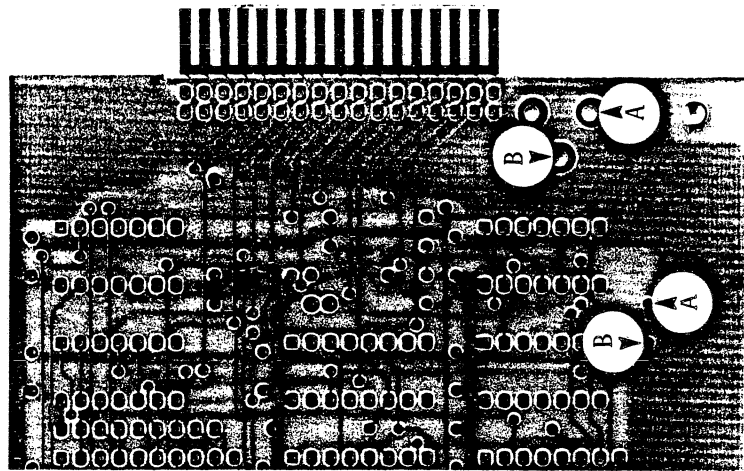

SOLDER SIDE



FLOPPY DISK ADAPTER: Allows user to run up to four 5¼" floppy disc drives. With power off, install in any available slot. Position DIP switch on motherboard according to the number of drives in use.

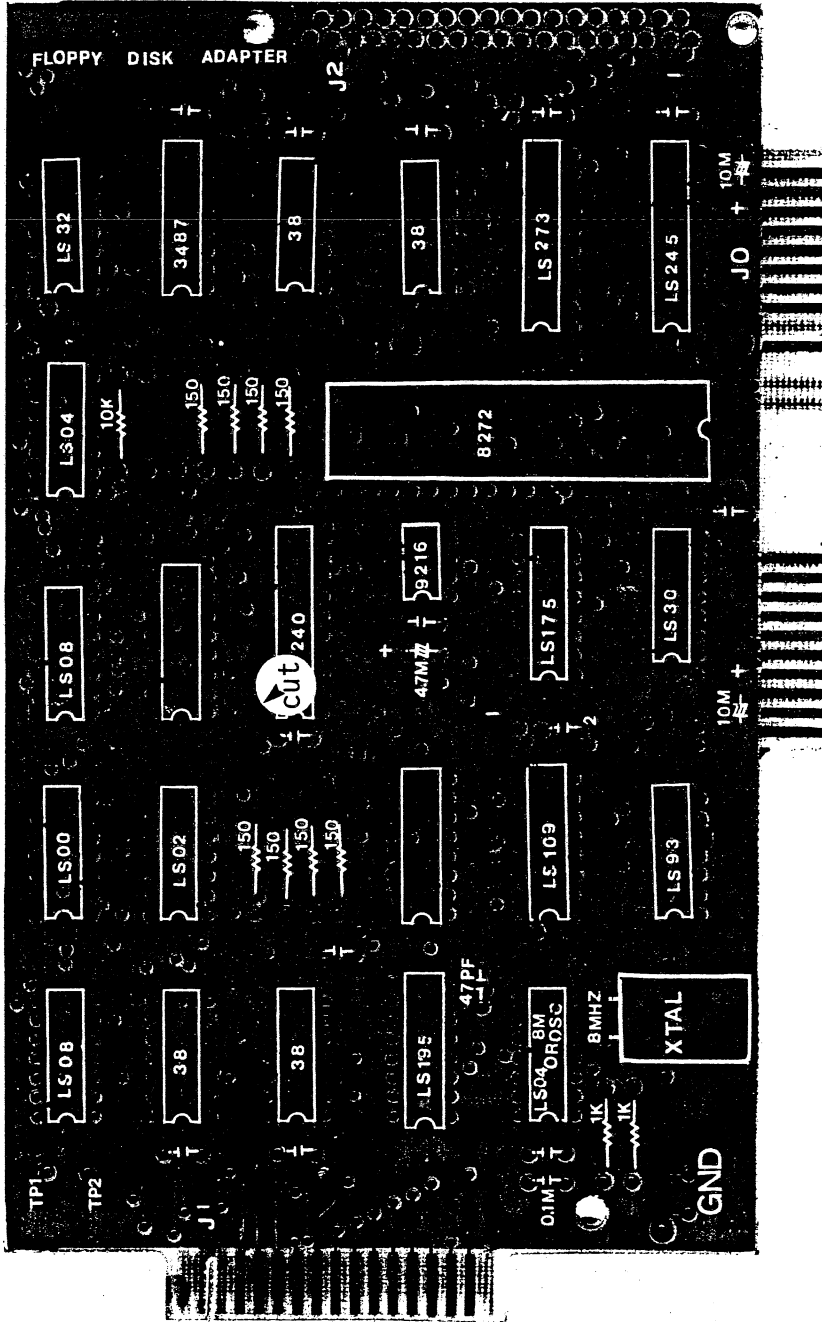

INTEGRATED CIRCUITS \*Match pin 1 of ICs with pin 1 on the layout

- 1 - 74LS00
- 1 - 74LS02
- 2 - 74LS04
- 2 - 74LS08
- 1 - 74LS30
- 1 - 74LS32
- 4 - 74LS38 @ 38
- 1 - 74LS93
- 1 - 74LS109
- 1 - 74LS175
- 1 - 74LS195
- 1 - 74LS240
- 1 - 74LS245
- 1 - 74LS273
- 1 - MC 3487
- 1 - FDC9216 (8-pin)
- 1 - 8272 (INTEL)

CRYSTAL Y \*Fold crystal flat against the card before soldering

CONNECTOR

1 - rear panel adapter

\*MODIFICATION: Cut "short" between feed-thru hole and land as shown on the layout

SUGGESTED SEQUENCE

\*INDICATES A PRECAUTION

RESISTORS R ¼ watt, 5%

- 8 - 150 Ω
- 2 - 1 KΩ
- 1 - 10 KΩ

SOCKETS \*Match pin 1 of sockets with pin 1 on the layout. Check that ALL pins have passed thru ALL holes

- 1 - 8-pin
- 13 - 14-pin

\*MODIFICATION REQUIRED

SOCKETS (continued)

- 4 - 16-pin
- 3 - 20-pin
- 1 - 40-pin

CAPACITORS C \*Match + of caps with

- 1 - 47 pF + on the layout
- 14 - 0.1 μF Monolithic @
- 1 - 4.7 μF/25V Tantalum\*
- 2 - 10 μF/25V Tantalum\*

\*Match + of caps with + on layout



HAL DRIVE CONTROLLER/PARALLEL PORT CARD: Supplies an interface between the computer and a) up to four 5¼" disk drives, and b) a parallel printer or other device that uses a parallel port. With power off, install in any free slot. Documentation available from supplier.

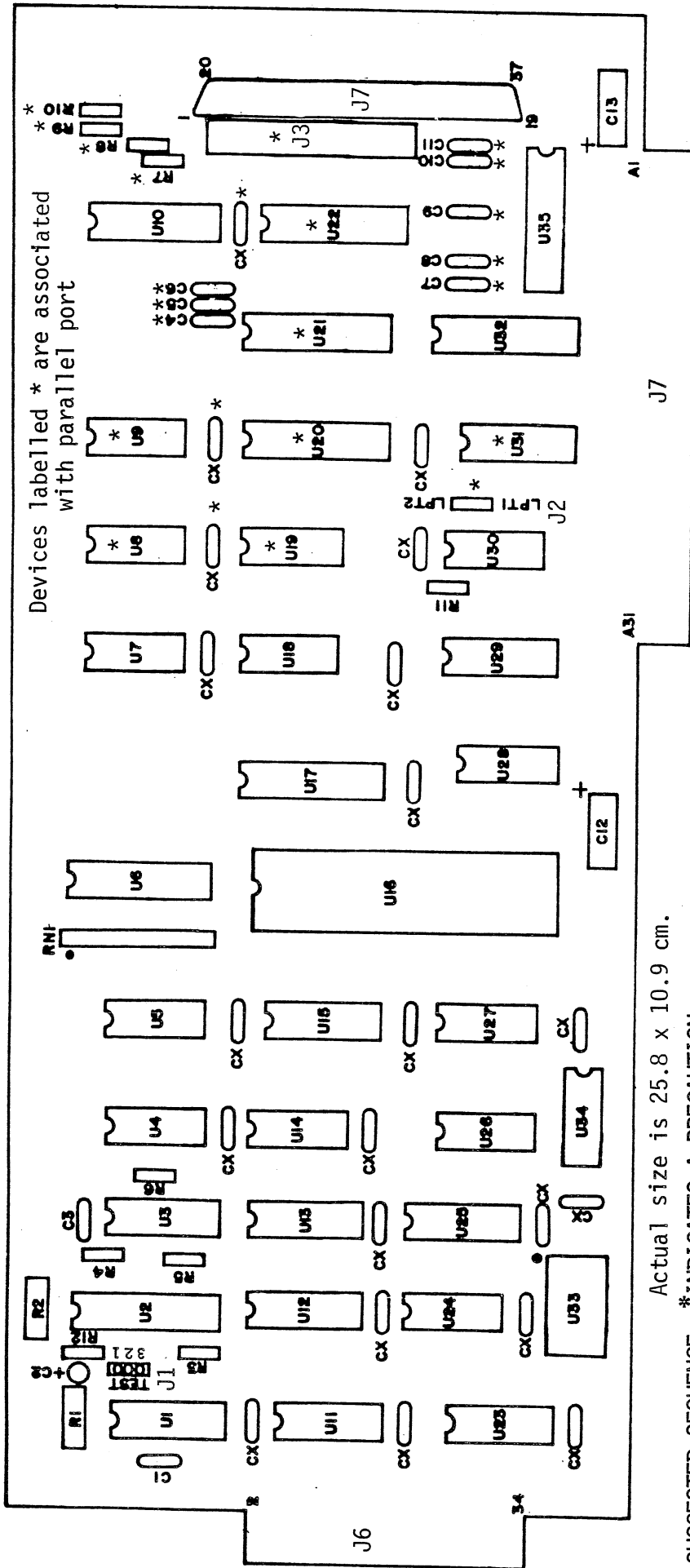

Actual size is 25.8 x 10.9 cm.

SUGGESTED SEQUENCE \* INDICATES A PRECAUTION

- RESISTORS R ¼ watt, 5%  
 1 - 100 Ω @ R12  
 2 - 2 KΩ @ R5,11  
 4 - 4.7 KΩ @ R7,8,9,10  
 1 - 12 KΩ @ R6  
 1 - 47 KΩ @ R3  
 1 - 68 KΩ @ R4  
 1 - 150 Ω 10-pin SIP\* @ RN1  
 \*Match pin 1 of SIP with pin 1 (dot) on the layout

- RESISTORS (continued)  
 2 - 50 KΩ single turn Trimpot @ R1,2

- SOCKETS \*Match pin 1 of sockets with pin 1 on the layout. Check that ALL pins have passed thru ALL holes  
 14 - 14-pin pin 1  
 10 - 16-pin  
 9 - 20-pin  
 1 - 40-pin

- CAPACITORS C  
 2 - 47 pF @ C1,3  
 8 - 0.0022 μF @ C4,5,6,7,8,9,10,11  
 22 - 0.1 μF Monolithic @ CX  
 \*Match + of the following capacitors with + on the layout  
 1 - 0.68 μF/25V Tantalum\* @ C2  
 2 - 22 μF/16V Axial\* @ C12,13

HAL DRIVE CONTROLLER/PARALLEL PORT CARD

CRYSTAL Y \*Match pin 1 of oscillator with pin 1 (dot) on the layout  
1 - 8.0000 MHz oscillator package @ U33

CONNECTORS

2 - 1x3 headers, male, straight @ J1 TEST  
1 - 2x13 header, male, straight @ J2 parallel port select @ J3  
1 - DB25S female, 90°, PCB mount @ J4  
1 - Jumper plug for J2  
1 - rear panel adapter

INTEGRATED CIRCUITS \*Match pin 1 of ICs with pin 1 on the layout

1 - 74LS00 @ U18  
1 - 74LS02 @ U28  
1 - 74LS04 @ U34  
2 - 74LS08 @ U7,26  
1 - 74LS20 @ U30  
1 - 74LS109 @ U25  
1 - 74LS123 @ U3  
1 - 74LS125 @ U9  
1 - 74LS126 @ U27  
1 - 74LS138 @ U29  
1 - 74LS153 @ U13  
1 - 74LS155 @ U31  
1 - 74LS174 @ U19  
2 - 74LS175 @ U12,15  
4 - 74LS240 @ U6,10,20,32  
1 - 74LS244 @ U21  
1 - 74LS245 @ U35  
1 - 74LS273 @ U17  
1 - 74LS293 @ U24  
1 - 74LS374 @ U22  
1 - 74LS629 @ U1

(continued)

INTEGRATED CIRCUITS (continued)

1 - 7405 @ U8  
5 - 7438 @ U4,5,11,14,23  
1 - 765AC @ U16  
1 - WD1691 @ U2

\*The ICs @ U8,9,19,20,21,22,31 are associated with the parallel port  
ALIGNMENT: Without correct alignment, the controller may appear to function normally but may produce diskettes that cannot be used on other computers  
ALIGNMENT PROCEDURE: Refer to J1 TEST. Ground pin 2. Connect an oscilloscope to pin 1 & adjust R1 for 1.35 ± 0.05 V. Connect scope to pin 3 & adjust R2 for 4 MHz display.

HAL DRIVE CONTROLLER/PARALLEL PORT CARD (continued)

Bare card with incomplete silk-screening:

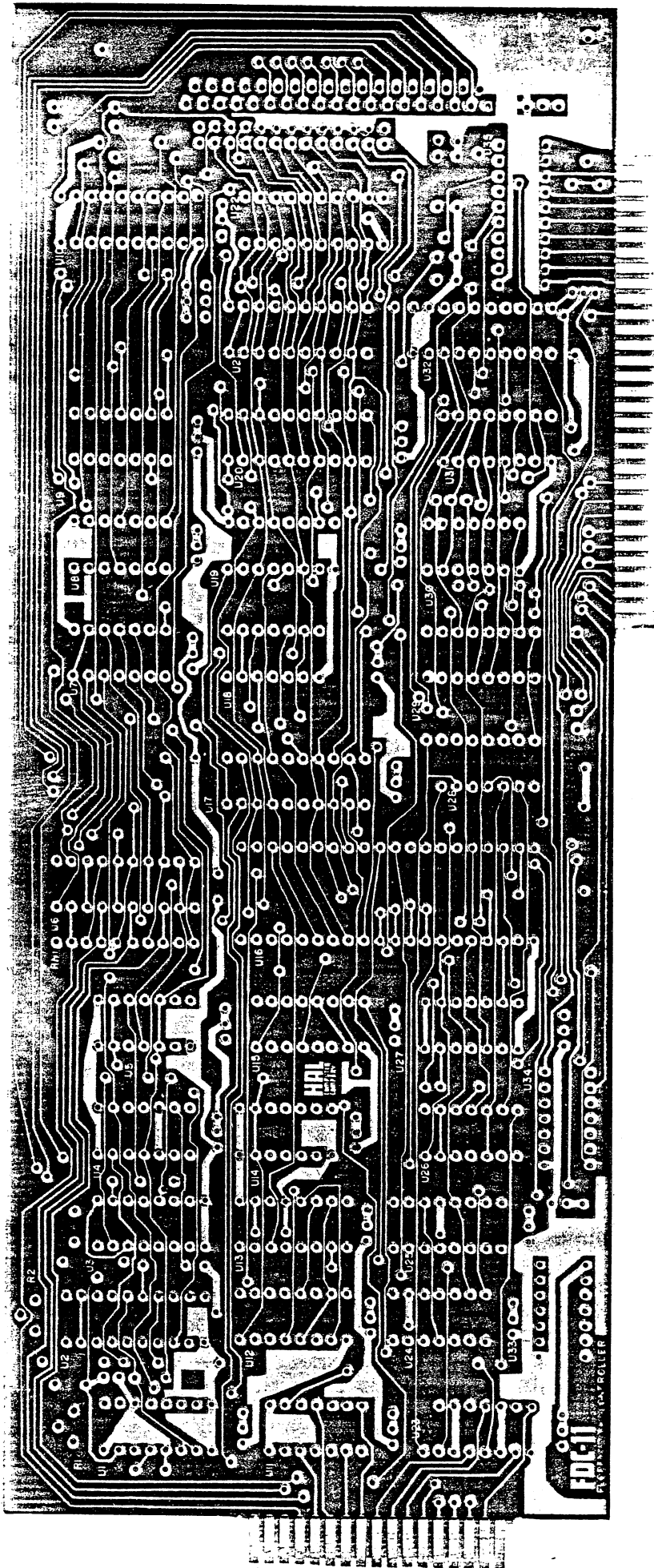



EK DISK CONTROLLER CARD: Allows user to run up to four 5¼" floppy disc drives. With power off, install in any vacant slot. Position DIP switch on motherboard according to the number of disk drives in use.

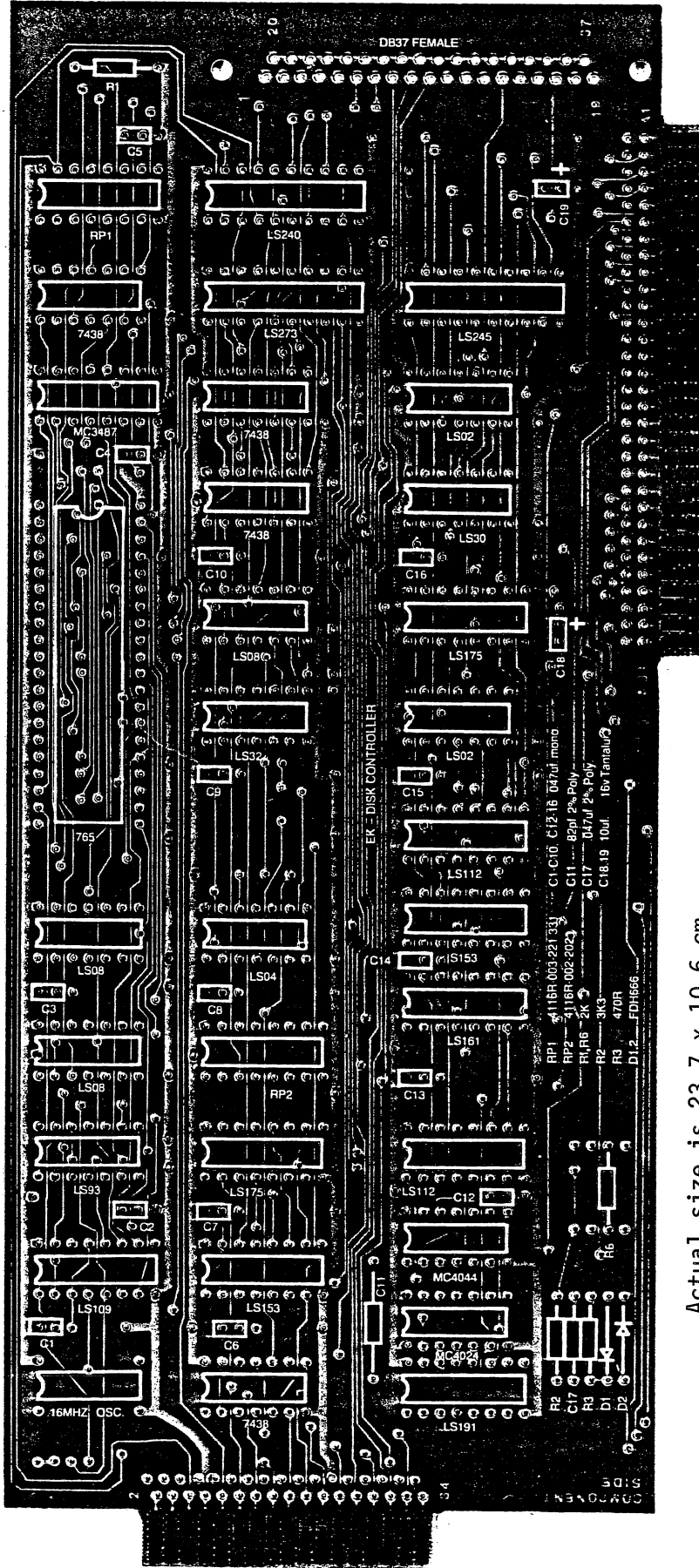

Actual size is 23.7 x 10.6 cm.

SUGGESTED SEQUENCE \*INDICATES A PRECAUTION

- DIODES D \*Position banded end (cathode) SOLETS \*Match pin 1 of sockets with pin 1 on the layout. Check that ALL pins have passed thru ALL holes.
- RESISTORS R ¼ watt, 5%  
 1 - 470 Ω @ R3  
 2 - 2 KΩ @ R1,6  
 1 - 3.3 KΩ @ R2  
 1 - 2 KΩ 16-pin DIP @ RP2  
 1 - 220/330 Ω 16-pin DIP @ RP1
- CAPACITORS C  
 1 - 82 pF 2% Polystyrene @ C11  
 1 - 0.047 μF 2% Polystyrene @ C17
- SOLETS \*Match pin 1 of sockets with pin 1 on the layout. Check that ALL pins have passed thru ALL holes.
- CAPACITORS (continued)  
 15 - 0.047 μF Monolithic @ C1,2,3,4,5,6,7,8,9,10,12,13,14,15,16  
 2 - 10 μF/16V Tantalum\* @ C18,19  
 \*Match + of Tantalum with + on the layout

EK DISK CONTROLLER CARD (continued)

OSCILLATOR

1 - 16.000 MHz

CONNECTORS

1 - DC37S female, 90°, PCB mount  
for two 5¼ external drives  
1 - rear panel adapter

DR37K

INTEGRATED CIRCUITS \*Match pin 1 of ICs

with pin 1 on the layout

2 - 74LS02  
1 - 74LS04  
3 - 74LS08  
1 - 74LS30  
1 - 74LS32  
1 - 74LS93  
1 - 74LS109  
2 - 74LS112  
1 - 74LS153  
1 - 74LS161  
2 - 74LS175  
1 - 74LS191  
1 - 74LS240  
1 - 74LS245  
1 - 74LS273  
1 - 74S153

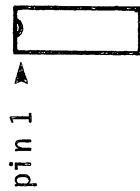

4 - 7438  
1 - MC3487  
1 - MC4024  
1 - MC4044  
1 - D765AC



GUIDE 2-6

ECS-4 DISC CONTROLLER CARD: Allows user to run up to four 5 1/4" floppy disk drives. With power off, install in any available slot. Set DIP switches on motherboard according to the number of drives in use.

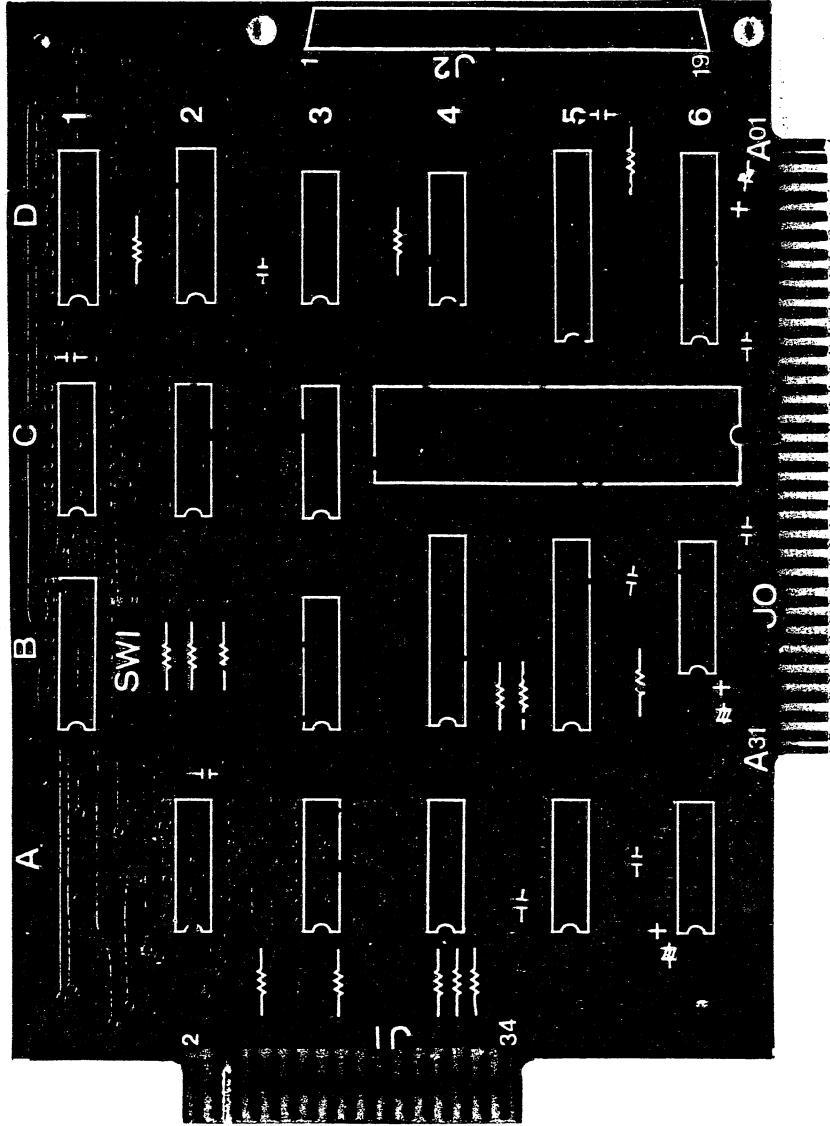

Actual size is 14.8 x 10.8 cm.

SUGGESTED SEQUENCE \*INDICATES A PRECAUTION

RESISTORS R 1/4 watt, 5%

- 8 - 150 Ohms @ co-ordinates: A2-3; three @ A4; two @ B4-5; B5-6; D3-4
- 3 - 2 K Ohms @ A3; D1-2; D5-6
- 3 - 4.7 K Ohms @ B2

SOCKETS \*Match pin 1 of sockets with pin 1 on the layout. Check that ALL pins have passed thru ALL holes

- 12 - 14-pin
- 2 - 16-pin
- 4 - 20-pin
- 1 - 40-pin

CAPACITORS C

- 9 - 0.1 uF Monolithic @
- 3 - 3.3 uF/16V Tantalum\* @ + \*Match + of Tantalum with + on the layout

SOCKETS (continued)

- 1 - 8-position DIP @ SW1

SWITCH

- 1 - 8-position DIP @ SW1

CONNECTORS

- 1 - DB37S 37-pin female, 90 degrees, PCB mount, @ J2

OSCILLATOR \*Install oscillator in socket

- 1 - 8.000 MHz @ A6

INTEGRATED CIRCUITS \*Match pin 1 of ICs with pin 1 on the layout

- 1 - 74LS00 @ B3
- 1 - 74LS02 @ A5
- 1 - 74LS04 @ C2
- 2 - 74LS08 @ A2, C3
- 1 - 74LS30 @ B6
- 1 - 74LS32 @ C1
- 4 - 74LS38 @ A3, A4, D3, D4
- 1 - 74LS165 @ D1
- 1 - 74LS240 @ B4
- 1 - 74LS245 @ D6
- 1 - 74LS273 @ D5

- 1 - 3487 @ D2
- 1 - 9229 @ B5
- 1 - 765AC @ C5

SWITCH SW1 SETTINGS:

number of drives	settings
0	1 7 8 on on on
1	1 7 8 off on on
2	1 7 8 off off on
3	1 7 8 off off off
4	1 7 8 off off off



GUIDE 3-1

JLS OBM-1 MEMORY/SERIAL CARD: Allows user to add a) 64K, 128K, 192K, or 256K bytes of dynamic RAM, and b) one RS-232 serial port using the optional ICs indicated in the parts list, to the motherboard. Schematics are available from the supplier.

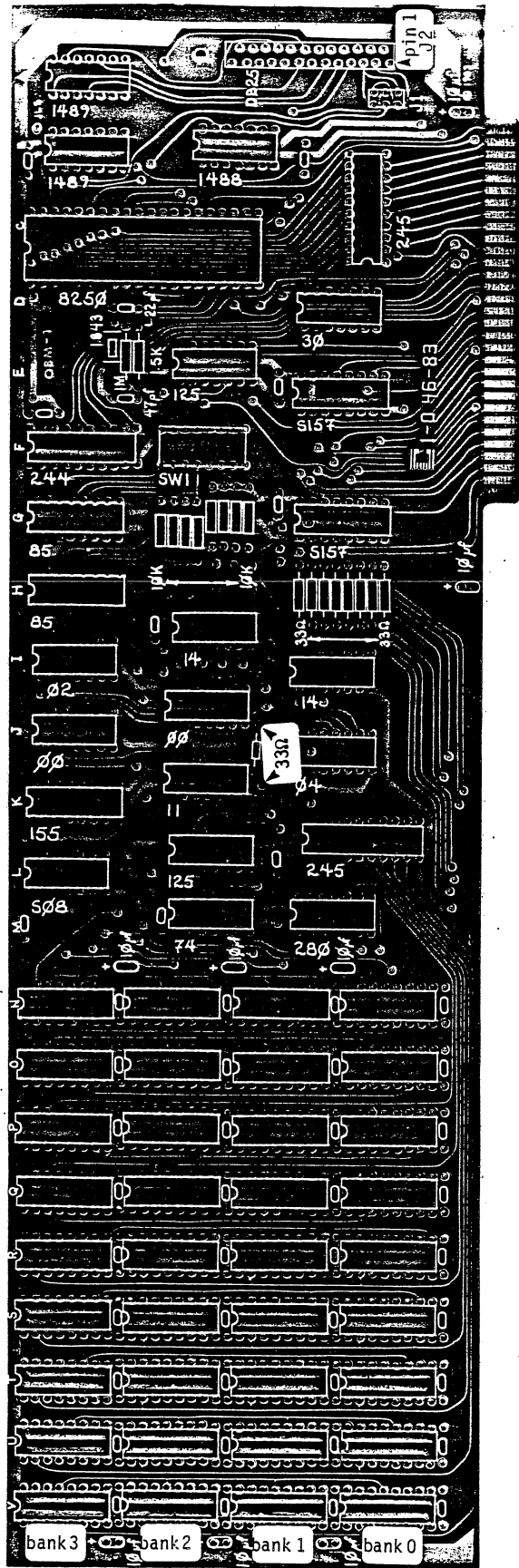

Layout is reduced. Actual size is 32.9 x 10.8 cm.

SUGGESTED SEQUENCE \* INDICATES A PRECAUTION \* MODIFICATION REQUIRED

- RESISTORS R 1/4 watt, 5%  
 9 - 33 Ω \*Note position of one of the resistors on the layout  
 1 - 1.5 KΩ  
 8 - 10 KΩ  
 1 - 1 MΩ
- SOCKETS \*Match pin 1 of sockets with pin 1 on the layout. Check that ALL pins have passed thru ALL holes  
 16 - 14-pin  
 41 - 16-pin  
 3 - 20-pin  
 1 - 40-pin
- CONNECTORS  
 1 - DB25P male, 90°, PCB mount @ J2  
 1 - rear panel adapter  
 1 - 2x3 header, male, straight @ J1  
 Strap J1 as follows:  
 i FOR MODEM  
 strap { : }strap  
 ii FOR TERMINAL  
 strap { : }strap
- CAPACITORS C  
 1 - 22 pF  
 1 - 47 pF  
 45 - 0.1 μF Monolithic @  
 8 - 10 μF/16V Tantalum \*Match + with + on the layout
- CRYSTAL Y \*Fold crystal flat against the card before soldering  
 1 - 1.8432 MHz @ 1.843
- SWITCH  
 1 - 8-position DIP @ SW1

**JLS OBM-1 MEMORY/SERIAL CARD (continued):**

**INTEGRATED CIRCUITS** \*Match pin 1 of ICs with pin 1 on the layout

- 2 - 74LS00
- 1 - 74LS02
- 1 - 74LS04
- 1 - 74S08\* (or 74LS08)
- 1 - 74LS11
- 2 - 74LS14
- 1 - 74LS30
- 1 - 74LS74
- 2 - 74LS85
- 2 - 74LS125 (optional)
- 1 - 74LS155
- 1 - 74LS244
- 2 - 74LS245
- 1 - 74LS280\* (or 74S280)
- 2 - 74S157 (no substitute)
- 1 - 1488 (optional)
- 2 - 1489 (optional)
- 1 - 8250B (optional)
- 36 - 4164 dynamic RAM, 200 ns

If parity error exists, substitute 74LS08 for 74S08  
74S280 for 74LS280

**SWITCH SWI SETTINGS:**

The switch, SW-1, located at co-ordinates 2-F, addresses memory anywhere in a one megabyte field through a continuous bank. Set the switches according to the following protocol:

starting bank	starting address	settings 1	settings 2	settings 3	settings 4	ending bank	ending address	settings 5	settings 6	settings 7	settings 8	
0	0K	....	on	on	on	0	....	64K	....	on	on	on
1	64K	....	off	on	on	1	....	128K	....	off	on	on
2	128K	....	on	off	on	2	....	192K	....	on	off	on
3	192K	....	off	off	on	3	....	256K	....	off	off	on

- EXAMPLE 1:** for 0K to 64K bytes (one bank)  
set 1, 2, 3, 4 to on; set 5, 6, 7, 8 to on
- EXAMPLE 2:** for 0K to 256K bytes (four banks)  
set 1, 2, 3, 4 to on; set 5, 6 off & 7, 8 on

\*The motherboard switch settings (SW2) must be set accordingly.

**MODIFICATION: \*ON THE SOLDER SIDE**  
cut trace between pin 1 of 8250 and ground on the solder side as shown

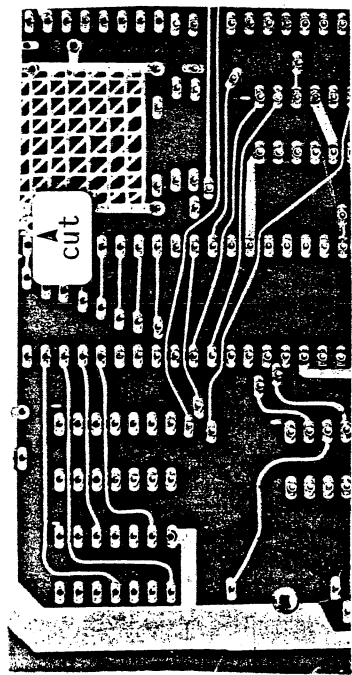



HAL MEMORY/SERIAL CARD: Allows user to add: a) 64K, 128K, 192K, or 256K bytes of dynamic RAM, and b) one RS-232 serial port (using the optional ICs indicated in the parts list), to the motherboard. Documentation and schematics are available from the supplier.

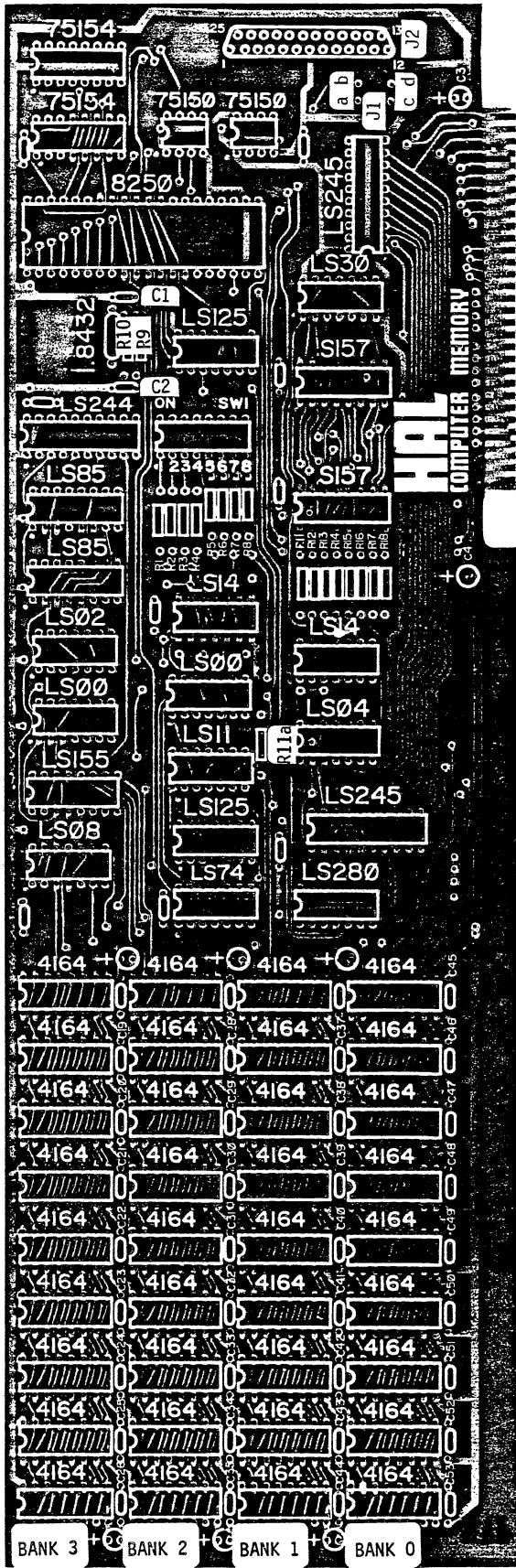

SUGGESTED SEQUENCE \*INDICATES A PRECAUTION Layout is reduced. Actual size is 32.8 x 11.7 cm.

- RESISTORS R ¼ watt, 5%
  - 9 - 33 Ω @ R11a, 11, 12, 13, 14, 15
  - 1 - 1.5 KΩ @ R9
  - 8 - 10 KΩ @ R1, 2, 3, 4, 5, 6, 7, 8
  - 1 - 1 MΩ @ R10
- SOCKETS \*Match pin 1 of sockets with pin 1 on the layout. Check that ALL pins have passed thru ALL holes
  - 2 - 8-pin
  - 12 - 14-pin
  - 43 - 16-pin
  - 3 - 20-pin
  - 1 - 40-pin
- CAPACITORS C
  - 1 - 22 pF @ C1
  - 1 - 47 pF @ C2
  - 45 - 0.1 μF Monolithic @ \*C
  - 8 - 10 μF/16V Tantalum \*Match + with + on the layout @
- CRYSTAL \*Fold crystal flat against the card before soldering
  - 1 - 1.8432 MHz @ 1.8432
- SWITCH
  - 1 - 8-position DIP @ SW1
- CONNECTORS
  - 1 - DB25, male, 90°, PCB mount @ J2
  - 4 - jumper pins, straight @ J1
  - 1 for modem connection:
    - jumper a to c,
    - & b to d
  - ii for terminal connection:
    - jumper a to d,
    - & b to c
  - 1 - rear panel adapter

HAL MEMORY/SERIAL CARD (continued)

INTEGRATED CIRCUITS \*Match pin 1 of

ICs with pin 1 on the layout

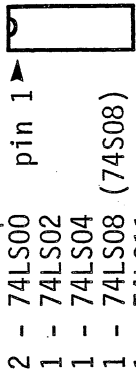

- 2 - 74LS00 pin 1
- 1 - 74LS02
- 1 - 74LS04
- 1 - 74LS08 (74S08)
- 1 - 74LS11
- 2 - 74LS14
- 1 - 74LS30 (optional)
- 1 - 74LS74
- 2 - 74LS85
- 2 - 74LS125
- 1 - 74LS155
- 1 - 74LS244
- 2 - 74LS245
- 1 - 74LS280 \*use 74S280 if parity error exists
- 2 - 74S157
- 2 - 75150 (optional)
- 2 - 75154 (optional)
- 1 - 8250B (optional)
- 36 - 4164 dynamic RAM, 200ns

**SWITCH SETTINGS - MEMORY BOARD SWITCH**

Switch SW1 is used to set the memory anywhere in the allowable one megabyte field in a continuous 64k to 256k block. Switch positions 1 to 4 indicate the starting 64k bank number (starting with bank 0), and switch positions 5 to 8 indicate the highest 64k bank in use.

Note that the motherboard switch SW2 must be set to agree with the memory board switch settings.

Memory Range	Switch Positions									
	Starting Bank	1	2	3	4	Ending Bank	5	6	7	8
0k-64k	0	ON	ON	ON	ON	0	ON	ON	ON	ON
64k-128k	1	OFF	ON	ON	ON	1	OFF	ON	ON	ON
128k-192k	2	ON	OFF	ON	ON	2	ON	OFF	ON	ON
192k-256k	3	OFF	OFF	ON	ON	3	OFF	OFF	ON	ON
256k-320k	4	ON	ON	OFF	ON	4	ON	ON	OFF	ON
320k-384k	5	OFF	ON	OFF	ON	5	OFF	ON	OFF	ON
384k-448k	6	ON	OFF	OFF	ON	6	ON	OFF	OFF	ON
448k-512k	7	OFF	OFF	OFF	ON	7	OFF	OFF	OFF	ON
512k-576k	8	ON	ON	ON	OFF	8	ON	ON	ON	OFF
576k-640k	9	OFF	ON	ON	OFF	9	OFF	ON	ON	OFF
640k-704k	10	ON	OFF	ON	OFF	10	ON	OFF	ON	OFF
704k-768k	11	OFF	OFF	ON	OFF	11	OFF	OFF	ON	OFF
768k-832k	12	ON	ON	OFF	OFF	12	ON	ON	OFF	OFF
832k-896k	13	OFF	ON	OFF	OFF	13	OFF	ON	OFF	OFF
896k-960k	14	ON	OFF	OFF	OFF	14	ON	OFF	OFF	OFF
960k-1024k	15	OFF	OFF	OFF	OFF	15	OFF	OFF	OFF	OFF



EXPLORER MEMORY/SERIAL CARD: Allows user to add: a) 64K, 128K, 192K, or 256K bytes of dynamic RAM, and b) one RS232 serial port (using optional ICs shown in the parts list), to the motherboard.

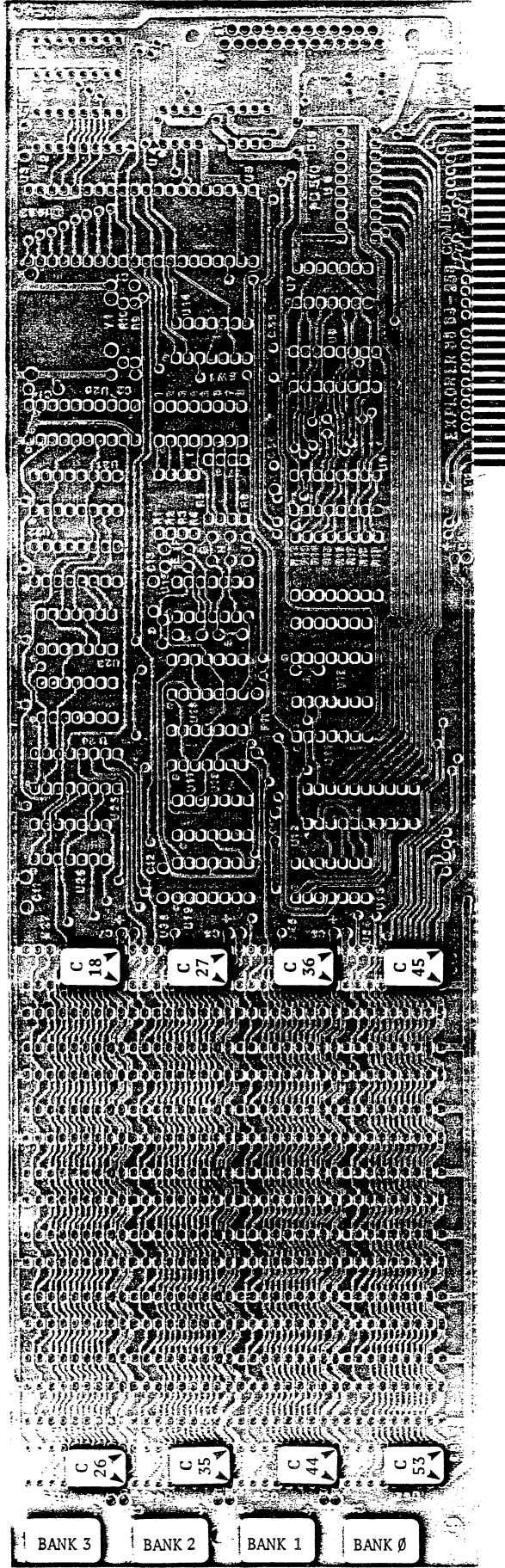

Layout is reduced. Actual size is 33.7 x 11.9 cm

**SUGGESTED SEQUENCE \*INDICATES A PRECAUTION \*SOLDER HOLES ARE LARGER THAN PLATED-THRU HOLES**

- RESISTORS R 1/4 watt, 5%
  - 9 33 Ω @ R11,12,13,14,15,16, R17,18,19
  - 1 - 1.5 KΩ @ R9
  - 8 - 10 KΩ @ R1,2,3,4,5,6,7,8
  - 1 - 1 MΩ @ R10
- SOCKETS \*Match pin 1 of sockets with pin 1 (dot) on the layout. Check that ALL pins have passed thru ALL holes before soldering
  - 2 - 8-pin
  - 12 - 14-pin
  - 43 - 16-pin
  - 3 - 20-pin
  - 1 - 40-pin
- CAPACITORS C
  - 1 - 22 pF @ C1
  - 1 - 47 pF @ C2
  - 45 - 0.1 μF Monolithic @ C11,12,13,14, C15,16,17,54,55
  - C18 to 26 between sockets of BANKS 3 & 2
  - C27 to 35 between sockets of BANKS 2 & 1
  - C36 to 44 between sockets of BANKS 1 & 0
  - C45 to 53 below sockets of BANK 0
  - 8 - 10 μF/16V Tantalum\* @ C3,4,5,6,7, C8,9,10
- CRYSTAL Y \*Fold crystal flat against the card before soldering. Solder the body of the crystal to the grounding pads
  - 1 - 1.8432 MHz @ Y1
- SWITCH
  - 1 - 8-position DIP @ SW1
- CONNECTORS
  - 1 - DB25P 90°, male, PCB mount @ J2
  - 4 - jumper pins, straight @ K,L for modem connection
    - jumper 1 to 2 & 3 to 4 for terminal connection
    - jumper 2 to 3 & 1 to 4 for rear panel adapter

EXPLORER MEMORY/SERIAL CARD (continued):

- INTEGRATED CIRCUITS \*Match pin 1 of ICs with pin 1 (dot) on the layout
- 2 - 74LS00 @ U16,24
  - 1 - 74LS02 @ U23
  - 1 - 74LS04 @ U11
  - 1 - 74LS08 @ U26 (or 74S08)
  - 1 - 74LS11 @ U17
  - 2 - 74LS14 @ U10,15
  - 1 - 74LS30 @ U7
  - 1 - 74LS74 @ U19
  - 2 - 74LS85 @ U21,22
  - 2 - 74LS125 @ U14,18
  - 1 - 74LS155 @ U2,5
- 1 - 74LS244 @ U20
  - 2 - 74LS245 @ U6,12
  - 1 - 74LS280 @ U13\*
  - 2 - 74S157 @ U8,9
  - 2 - 75150 @ U4,5
  - 2 - 75154 @ U1,2
  - 1 - 8250B @ U3
  - 36 - 4164 Dynamic RAM, 200 ns @ U27 to 62
- ICs marked + are optional (serial port)  
 \*Replace 74LS280 @ U13 with 74S280 if parity error exists

SWITCH SETTINGS

The switch SW-1, located at co-ordinates 2-F, addresses memory anywhere in a one megabyte field through a continuous bank. Set the switches according to the following protocol:

starting bank	starting address	settings 1	settings 2	settings 3	settings 4	ending bank	ending address	settings 5	settings 6	settings 7	settings 8
0	0K	on	on	on	on	0	64K	on	on	on	on
1	64K	off	on	on	on	1	128K	off	on	on	on
2	128K	on	off	on	on	2	192K	on	off	on	on
3	192K	off	off	on	on	3	256K	off	off	on	on

EXAMPLE 1: for 0K to 64K bytes (one bank)  
 set 1, 2, 3, 4 to on; set 5, 6, 7, 8 to on

EXAMPLE 2: for 0K to 256K bytes (four banks)  
 set 1, 2, 3, 4 to on; set 5, 6 off & 7, 8 on

\*Motherboard switch SW2 must be set to agree with the memory switch settings.

## GUIDE 3-4

NuScope Associates

**512K RAM CARD:** Allows user to add 512 K bytes of dynamic RAM in steps of 64 K bytes. With power off, install in any free slot. Switch settings correspond to memory banks: set SW1 on for BANK $\emptyset$ ; SW2 on for BANK $\emptyset$ ; SW3 on for BANKS  $\emptyset$ ,1,2, ...etc. Motherboard switch settings must agree with memory on the card. Requires firmware (one PROM).

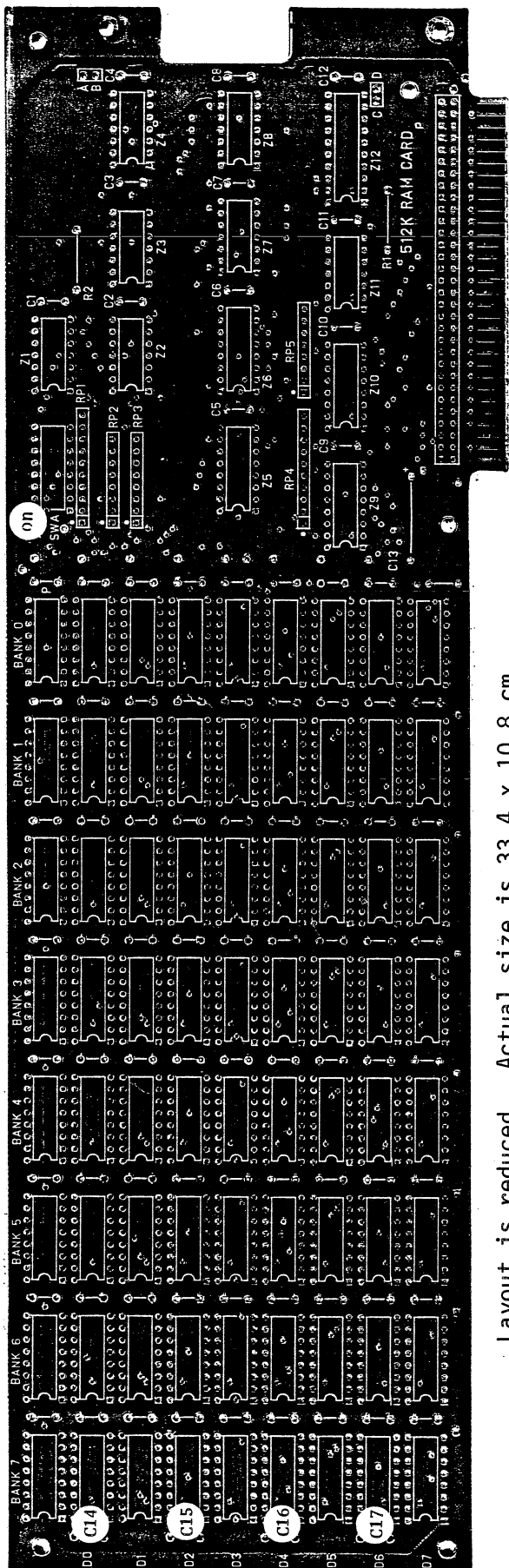

Layout is reduced. Actual size is 33.4 x 10.8 cm.

### SUGGESTED SEQUENCE \*INDICATES A PRECAUTION

RESISTORS R ¼ watt, 5%

2 - 33  $\Omega$  @ R1,2

\*Match pin 1 of the following SIP resistors with pin 1 (dot) on the layout

1 - 330  $\Omega$  10-pin SIP bussed @ RP1

3 - 22  $\Omega$  4-resistor SIP isolated @ RP2,3,5

1 - 22  $\Omega$  5-resistor SIP isolated @ RP4

SOCKETS \*Match pin 1 of sockets with pin

1 (square pad) on the layout. Check

that ALL pins have passed thru ALL

holes before soldering

SOCKETS (continued)

6 - 14-pin

77 - 16-pin

1 - 20-pin

CAPACITORS C

12 - 0.1  $\mu$ F Monolithic @ C1 to 16

72 - 0.1  $\mu$ F Monolithic @

1 - 15  $\mu$ F/25V Axial\* @ C13

\*Match + of axial

with + on the layout

SWITCH

1 - 8-position DIP @ SWA

CONNECTORS

2 - 2-pin header, male @ AB & CD

INTEGRATED CIRCUITS \*Match pin 1 of ICs

with pin 1 on the layout

1 - 74LS11 @ Z7 \*Z6 is not equipped

1 - 74LS30 @ Z1

1 - 74LS74 @ Z4

1 - 74LS125 @ Z11

1 - 74LS245 @ Z12

1 - 74S00 @ Z2

1 - 74S74 @ Z3

2 - 74S158 @ Z9,10

1 - 74S280 @ Z8

1 - 18S030 PROM @ Z5 (T.I.)

72 - 4164 RAM, 200 ns in steps of

64 K (nine 4164 ICs)

@ BANKS  $\emptyset$ ,1, 2,3,4,5,6,7,8



**COLOUR GRAPHICS DISPLAY CARD:** Allows user to interface the following with the computer: monochrome or colour composite monitor, RF modulator, lightpen. Card contains 16 K of dynamic RAM for storage information & operates in medium or high-resolution graphics mode, or low or high-resolution alphanumeric mode (40 or 80 characters by 25 rows). Requires firmware (one EPROM). With power off, install in any vacant slot. \*CAUTION: Damage may result if more than one colour adapter is installed in the system.

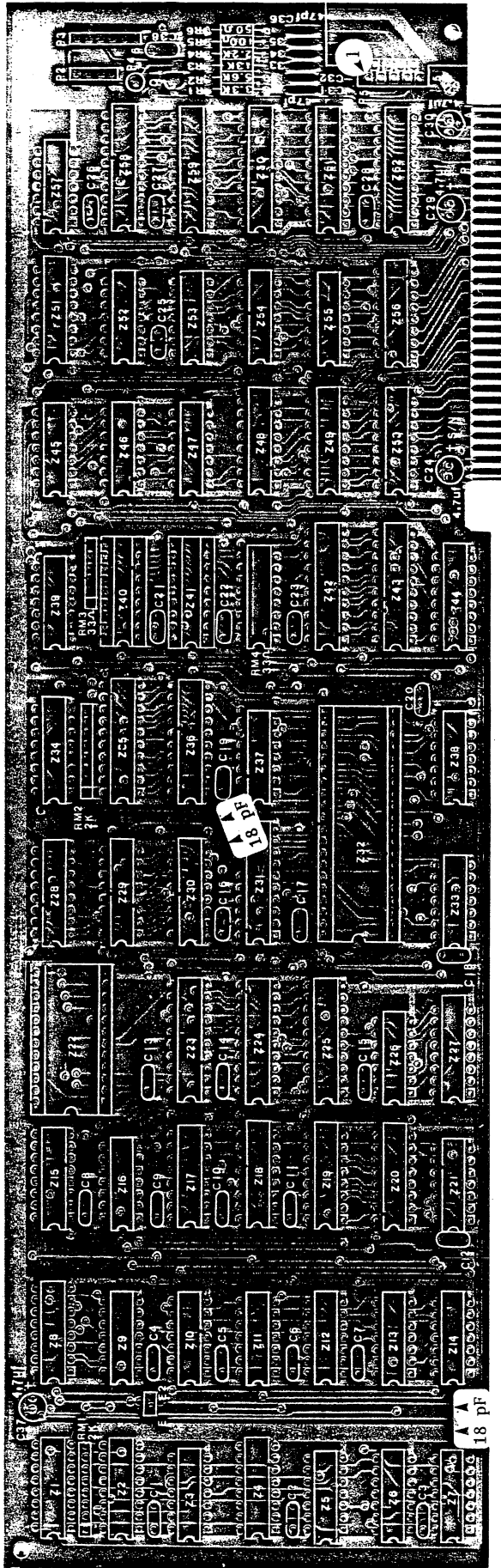

Layout is reduced. Actual size is 33.5 X 10.4 cm

**SUGGESTED SEQUENCE \*INDICATES A PRECAUTION**

- RESISTORS** R ¼ watt, 5%  
 1 - 50 Ω @ R6 *various 47K*  
 1 - 100 Ω @ R5  
 1 - 2.2 KΩ @ R4  
 1 - 3.3 KΩ @ R1 *various 3.0K*  
 1 - 5.6 KΩ @ R2  
 1 - 13 KΩ @ R3 *various 10K*
- \*Match pin 1 of SIP & DIP resistors with pin 1 (square pad) on the layout *various 1.2K 9.1M*
- 2 - 2 KΩ SIP, 8-pin @ RM1,2  
 1 - 33 Ω SIP, isolated, 6-pin @ RM3 or three 33 Ω on end  
 1 - 33 Ω DIP, 16-pin @ RM4
- SOCKETS**  
 \*Match pin 1 of sockets with pin 1 CAPACITORS (continued)  
 on the layout. Check that ALL 4 - 4.7 μF/35V Radial @ C24,29, pins have passed thru ALL holes C30,37  
 24 - 14-pin *no holes*  
 21 - 16-pin  
 2 - 18-pin  
 14 - 20-pin  
 1 - 24-pin  
 1 - 40-pin
- \*Match + of radials with + on the layout  
 \*Match the EBC transistor leads as shown
- CAPACITORS C**  
 2 - 18 pF @ positions shown on layout  
 6 - 47 pF @ C31,32,33,34,35,36  
 28 - 0.1 μF Monolithic @ C1-23,25,26,27, C28,38
- TRANSISTOR Q** \*Match the EBC transistor leads as shown  
 1 - 2N3904 *2SC945*
- Diagram:** A small schematic diagram of a transistor with pins labeled B (Base), C (Collector), and E (Emitter).

COLOUR GRAPHICS DISPLAY CARD (continued)

- CONNECTORS \*All headers are male, straight
- 1 - 1x2 header @ E1,E2 (Character Set Selection)
  - 1 - 1x4 header @ P2 (RF Modulator Strip) remove pin 2
  - 1 - 1x6 header @ P3 (Lightpen Strip) remove pin 2
  - 1 - 1-pin @ P4 (Composite Video) connect to hot of phono jack,
  - 1 - DE9S 9-position female receptacle, PCB mount @ P5 (Direct Drive - RGB)
  - 1 - phono jack (Composite Video) connect ground of jack to ground on card
  - 1 - jumper plug: with plug on E1,E2 vertical lines of characters are two dots wide; without plug, lines are one dot wide
  - 1 - rear panel adapter

INTEGRATED CIRCUITS \*Match pin 1 of ICs

with pin 1 (square pad) on the layout. Leave Z1,2,4,blank

- 2 - 74LS00 @ Z33,47
- 1 - 74LS02 @ Z12
- 1 - 74LS08 @ Z45
- 2 - 74LS10 @ Z14,55
- 1 - 74LS51 @ Z3
- 3 - 74LS74 @ Z5,38,52
- 1 - 74LS86 @ Z26
- 1 - 74LS125 @ Z54
- 3 - 74LS138 @ Z44,48,56
- 1 - 74LS163 @ Z8
- 1 - 74LS164 @ Z6
- 3 - 74LS166 @ Z28,29,30
- 2 - 74LS174 @ Z19,20
- 1 - 74LS175 @ Z51
- 3 - 74LS244 @ Z59,60,61
- 1 - 74LS245 @ Z62
- 5 - 74LS273 @ Z23,24,31,35,36
- 3 - 74LS374 @ Z42,43,58
- 1 - 74LS393 @ Z37



pin 1 lower left for ALL sockets

- 1 - 74S00 @ Z13
- 1 - 74S02 @ Z11
- 3 - 74S04 @ Z9,10,53
- 1 - 74S32 @ Z46
- 1 - 74S51 @ Z16
- 4 - 74S74 @ Z7,21,39,57
- 1 - 74S151 @ Z27
- 2 - 74S153 @ Z17,18
- 1 - 74S157 @ Z15
- 1 - 74S175 @ Z34
- 2 - 74S257 @ Z49,50
- 1 - 74S374 @ Z25
- 1 - 2732A EPROM @ Z22 Character generator
- 1 - 6845SP (Hitachi) @ Z32 CRT cont.
- 2 - TMS4416-15 ns (T.I.) @ Z40,41 Display memory

CONNECTOR PINOUTS

- P2: RF MODULATOR - with television set
- |                |           |
|----------------|-----------|
| colour card    | modulator |
| 1 +12V         | 1         |
| 2 not used     | 2         |
| 3 video output | 3         |
| 4 logic ground | 4         |
- P3: LIGHTPEN PINOUT - with lightpen
- |                |          |
|----------------|----------|
| colour card    | lightpen |
| 1 pen input    | 1        |
| 2 not used     | 2        |
| 3 pen switch   | 3        |
| 4 logic ground | 4        |
| 5 +5V          | 5        |
| 6 +12V         | 6        |
- P4: PHONO JACK - with composite video monitor
- |                    |               |
|--------------------|---------------|
| colour card        | video monitor |
| 1 peak-to-peak AMP | 1             |
| 2 chassis ground   | 2             |
- P5: DIRECT DRIVE - with direct drive monitor (RGB)
- |                    |         |
|--------------------|---------|
| colour card        | monitor |
| 1 ground           | 1       |
| 2 ground           | 2       |
| 3 red              | 3       |
| 4 green            | 4       |
| 5 blue             | 5       |
| 6 intensity        | 6       |
| 7 reserved         | 7       |
| 8 horizontal drive | 8       |
| 9 vertical drive   | 9       |

00 at Z13  
02 at Z11  
04



**FOUNTAIN MONOCHROME GRAPHICS CARD:** Offers: a) video - text mode (80 x 25 lines); graphics mode (720 columns x 348 addressable dots), b) parallel printer port, & c) 64 K bytes of display buffer. Do NOT use this card together with another monochrome card or colour card. Do NOT run the diagnostics program without making appropriate changes. With power off, install in any available slot. Documentation & schematics available from supplier. Requires EPROM.

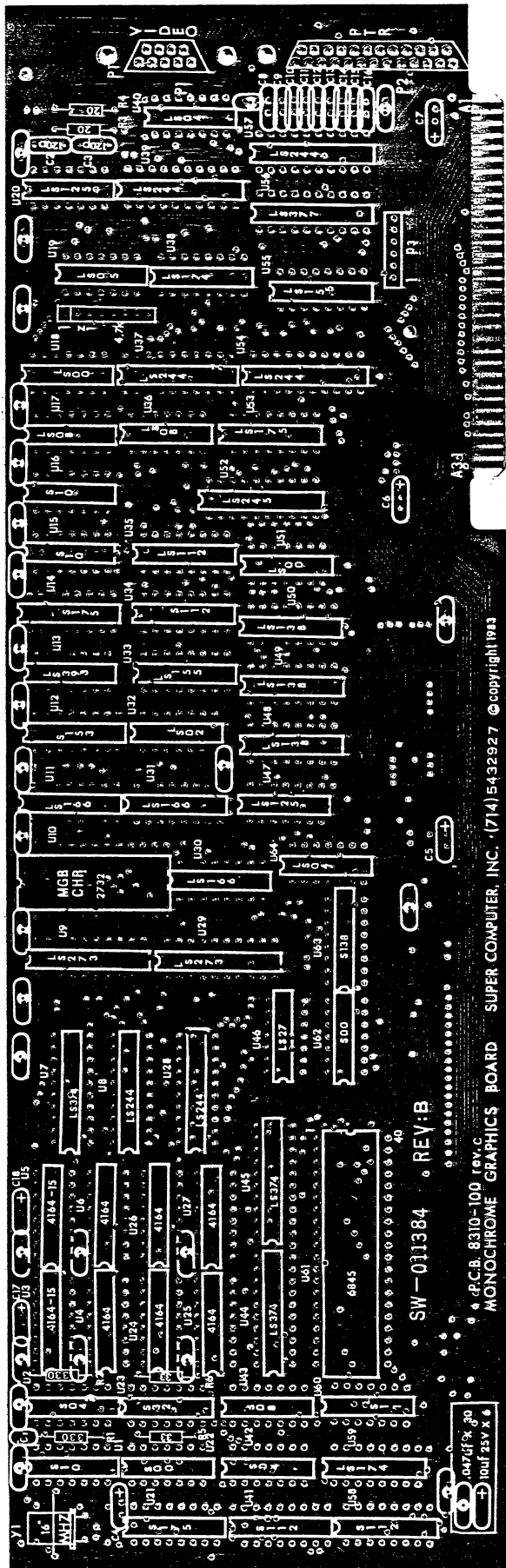

**SUGGESTED SEQUENCE \*INDICATES A PRECAUTION**

- RESISTORS** R ¼ watt, 5%  
 2 - 20 Ω @ R3,4  
 2 - 33 Ω @ R5,6  
 2 - 820 Ω @ R1,2  
 1 - 4.7 KΩ 8-pin SIP\* @ Z1  
 \*Match pin 1 of SIP with pin 1 on the layout

- SOCKETS** \*Match pin 1 of sockets with pin 1 on the layout. Check that ALL pins have passed thru ALL holes
- 22 - 14-pin pin 1
  - 27 - 16-pin
  - 13 - 20-pin
  - 1 - 24-pin
  - 1 - 40-pin



Layout is reduced.

- CAPACITORS** C  
 2 - 120 pF @ C2,3  
 10 - 0.01 μF @ C1,8,9,10,11,12,13,14, C15,16  
 30 - 0.1 μF Monolithic @ C  
 6 - 10 μF/25V Tantalum\* @ C4,5,6,7,17,18  
 \*Match + of Tantalums with + on the layout

Actual size is 33.3 x 11.7 cm.

**CRYSTAL** \*Fold crystal flat against the card before soldering. Solder the case to the two grounding pads at sides of crystal  
 1 - 16.0000 MHz @ Y1

**CONNECTORS**

- 1 - DE9S female, 90° @ P1, Video
- 1 - DB25S female, 90° @ P2, printer port
- 1 - 1x4 header, male, straight @ P3
- 1 - rear panel adapter + hardware

FOUNTAIN MONOCHROME GRAPHICS CARD (continued)

INTEGRATED CIRCUITS \*Match pin 1 of ICs

with pin 1 on the layout

- 2 - 74LS00 @ U18,51
- 1 - 74LS02 @ U32
- 2 - 74LS04 @ U40,64
- 1 - 74LS05 @ U19
- 2 - 74LS08 @ U17,36
- 1 - 74LS11 @ U60
- 1 - 74LS27 @ U46
- 1 - 74LS112 @ U35
- 2 - 74LS125 @ U20,47
- 3 - 74LS138 @ U48,49,50
- 2 - 74LS155 @ U33,55
- 3 - 74LS166 @ U11,30,31
- 2 - 74LS174 @ U38,59
- 1 - 74LS175 @ U53
- 6 - 74LS244 @ U8,28,37,39,54,57
- 1 - 74LS245 @ U52
- 2 - 74LS273 @ U9,29
- 4 - 74LS374 @ U7,44,45,56
- 1 - 74LS393 @ U13
- 2 - 74S00 @ U22,62
- 2 - 74S04 @ U2,42
- 1 - 74S08 @ U43
- 3 - 74S10 @ U1,15,16
- 1 - 74S32 @ U23
- 3 - 74S112 @ U34,41,58
- 1 - 74S138 @ U63
- 1 - 74S153 @ U12
- 2 - 74S175 @ U14,21
- 1 - 6845 CRT Controller @ U61
- 8 - 4164 RAM, 150 ns @ U3,4,5,6,  
U24,25,26,27
- 1 - 2732 EPROM, Character generator  
@ U10



**COLOR/GRAPHICS ADAPTER CARD:** Four-layered PCB with a) colour video & b) 16 k bytes of display buffer. Video mode: alphanumeric mode (40 columns x 25 rows or 80 columns x 25 rows); graphics mode (200 rows x 320 dots or 200 rows x 640 dots). Other video features include: interface with composite video port, direct drive (RGB) port, RF modulator & light pen. With power off, install in any available slot. Documentation & schematics available from supplier. Requires firmware (one EPROM).

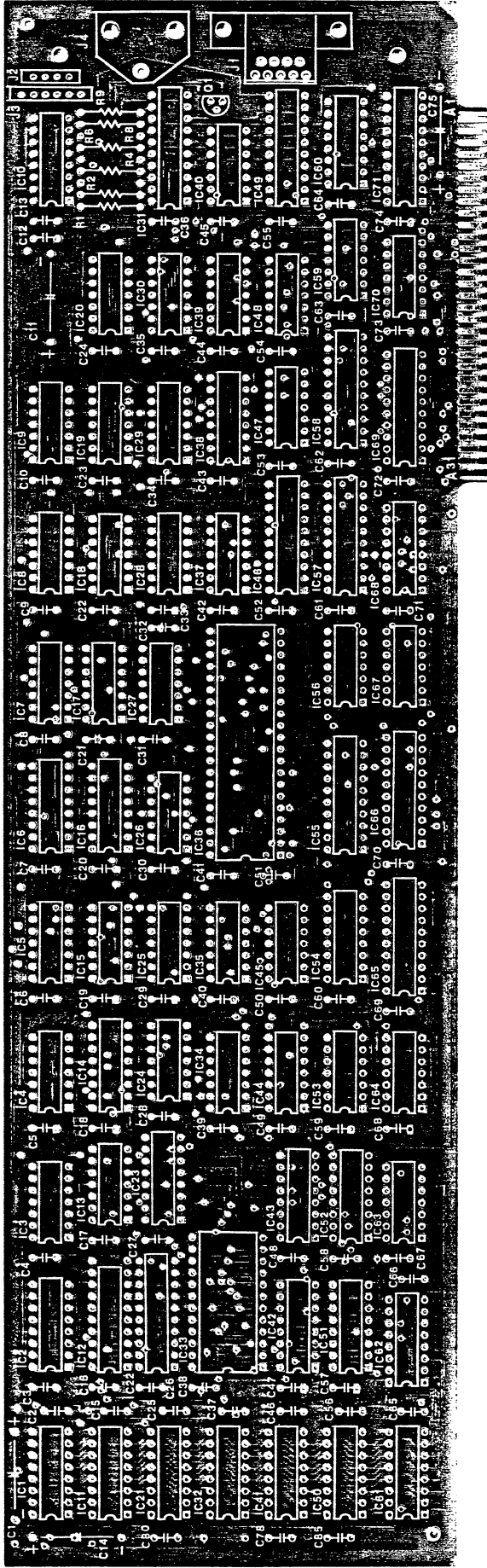

Layout is reduced. Actual size is 33.8 x 11.5 cm.

**SUGGESTED SEQUENCE \*INDICATES A PRECAUTION \*MODIFICATION REQUIRED**

**RESISTORS** R ¼ watt, 5%

- 1 - 51 Ω @ R9
- 1 - 100 Ω @ R1
- 1 - 2.2 KΩ @ R4
- 1 - 3.3 KΩ @ R2
- 1 - 5.6 KΩ @ R8
- 1 - 13 KΩ @ R6

- SOCKETS \* Match pin 1 of sockets with pin 1 on the layout. Check that ALL pins have passed thru ALL holes
- 39 - 14-pin
- 18 - 16-pin
- 12 - 20-pin
- 1 - 24-pin
- 1 - 40-pin

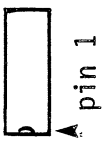

**CAPACITORS** C

- 4 - 2.2 μF/16V Axial\* @ C1,11,14,75
- \*Match + of Axial with + on the layout
- 50 - 0.1 F Monolithic @ all other positions labelled C

**CONNECTORS**

- 1 - DE9S 9-pin female, 90°, PCB mount, @ J1 (RGB)
- 1 - 1x4 header, male, straight, @ J2 (RF modulator)
- 1 - 1x6 header, male, straight, @ J3 (light pen)
- 1 - RCA phono jack @ J4 (composite video)
- 1 - rear panel adapter

COLOR/GRAPHICS ADAPTER CARD: (continued)

INTEGRATED CIRCUITS \*Match pin 1 of ICs

with pin 1 on the layout

- 2 - 74LS00 @ IC27,29
- 2 - 74LS02 @ IC5,67
- 4 - 74LS04 @ IC26,28,30,34
- 3 - 74LS08 @ IC24,40,47
- 1 - 74LS10 @ IC25
- 1 - 74LS14 @ IC8
- 2 - 74LS30 @ IC59,70
- 4 - 74LS32 @ IC37,44,48,56
- 2 - 74LS51 @ IC45,53
- 4 - 74LS74 @ IC3,9,19,20
- 3 - 74LS86 @ IC17,18,35
- 1 - 74LS125 @ IC39
- 1 - 74LS138 @ IC38
- 1 - 74LS151 @ IC14
- 2 - 74LS153 @ IC51,52
- 1 - 74LS158 @ IC6
- 1 - 74LS164 @ IC15
- 3 - 74LS166 @ IC2,23,42
- 3 - 74LS174 @ IC16,54,68
- 1 - 74LS175 @ IC10
- 4 - 74LS244 @ IC31,49,55,65
- 1 - 74LS245 @ IC71
- 2 - 74LS273 @ IC12,22
- 5 - 74LS374 @ IC46,57,58,66,69
- 1 - 74LS393 @ IC64
- 2 - 74S74 @ IC4,13
- 1 - 74S164 @ IC7
- 1 - 74S174 @ IC43
- 1 - 74S175 @ IC60
- 1 - 2716 2Kx8 EPROM @ IC33
- 8 - 4116 200 ns RAM @ IC1,11,21,32  
IC41,50,61,62
- 1 - 6845SP (Hitachi) @ IC36

CONNECTOR SPECIFICATIONS (pinout)

J1: DIRECT-DRIVE (RGB) MONITOR

color card	monitor
1	ground
2	ground
3	red
4	green
5	blue
6	intensity
7	reserved
8	horizontal drive
9	vertical drive

J2: RF MODULATOR

color card	modulator
1	+12V
2	not used
3	video output
4	logic ground

J3: LIGHT PEN

color card	lightpen
1	pen input
2	not used
3	pen switch
4	logic ground
5	+5V
6	+12V

J4: RCA JACK

color card	video monitor
1	video
2	ground



PG-2 MONOCHROME/GRAPHICS: Features a) both composite and monochrome video output - i) text mode, 80 x 25 lines, ii) graphics mode, 720 columns x 348 dots; b) 4 K bytes of display buffer. Requires firmware (one EPROM).

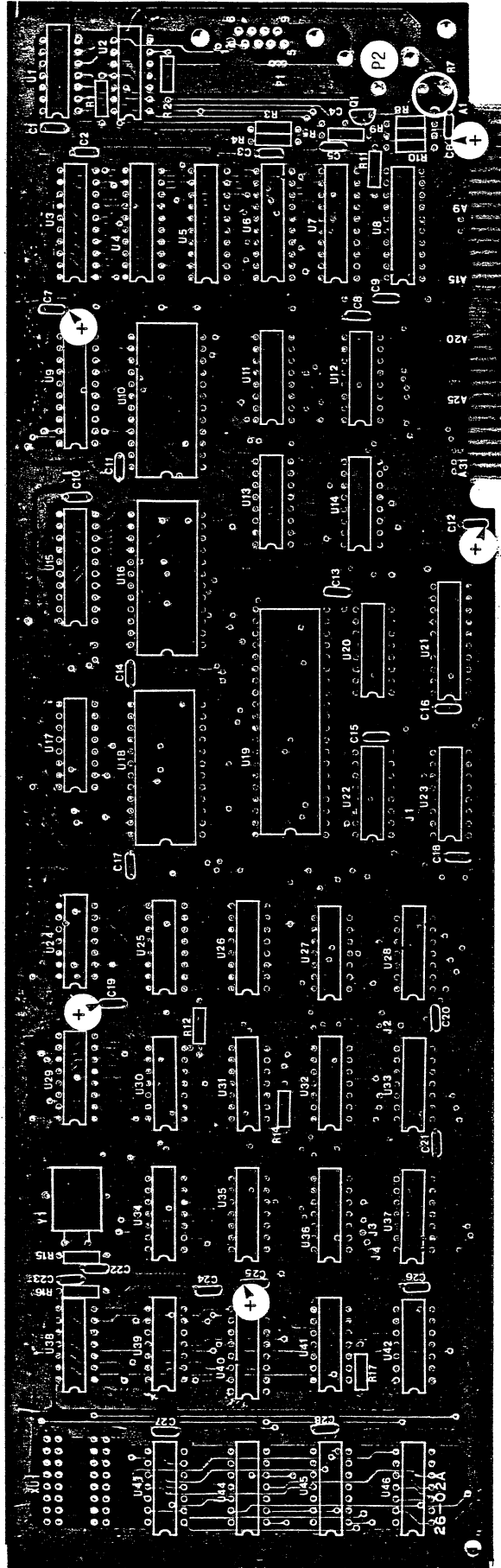

Layout is reduced. Actual size is 33.5 x 11.8 cm.

**SUGGESTED SEQUENCE \*INDICATES A PRECAUTION**

RESISTORS R ¼ watt, 5% \*R6, 13 are not shown  
 2 - 22 Ω @ R3,4  
 6 - 4.7 KΩ @ R1,2,12,14,15, R16,17  
 R2,5,7 to 11 are reserved for composite video

CAPACITORS C \*C24 - not equipped  
 1 - 47 pF @ C22  
 2 - 100 pF @ C4,5  
 1 - 0.001 μF @ C23  
 18 - 0.1 μF Monolithic @ C1,2,3,8, C9,10,11,13,14,15,16,17, C18,20,21,26,27,28  
 5 - 10 μF/16V Tantalum\* @ C6,7, C12,19,25  
 \*Match + of Tantalums with + on the layout

CRYSTAL Y \*Fold crystal flat against the card before soldering. Solder the case to the grounding pads  
 1 - 16.000 MHz @ Y1

**CONNECTORS**

1 - DE9S female, 90°, PCB mount @ P1 for video  
 1 - RCA phono jack @ P2 for composite video  
 4 - jumper pins @ J1,2,3,4 Strap J1 to J3 J2 to J4  
 1 - rear panel adapter

4 4 SOCKETS \*Match pin 1 of sockets with pin 1 on the layout. Check that ALL pins have passed thru ALL holes  
 21 - 14-pin  
 12 - 16-pin  
 9 - 20-pin  
 3 - 24-pin  
 1 - 40-pin  
 pin 1

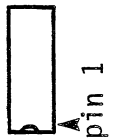

PG-2 MONOCHROME/GRAPHICS CARD (continued):

INTEGRATED CIRCUITS \*Match pin 1 of ICs

with pin 1 on the layout

- 2 - 74LS00 @ U28,36
- 2 - 74LS02 @ U24,35
- 3 - 74LS04 @ U1,27,38
- 2 - 74LS08 @ U37,44
- 1 - 74LS10 @ U43
- 1 - 74LS11 @ U39
- 1 - 74LS32 @ U34
- 5 - 74LS74 @ U31,32,33,41,46
- 1 - 74LS86 @ U30
- 2 - 74LS125 @ U2,42
- 3 - 74LS138 @ U12,20,22
- 2 - 74LS139 @ U17,23
- 3 - 74LS157 @ U11,13,14
- 1 - 74LS166 @ U25
- 3 - 74LS174 @ U26,29,40
- 4 - 74LS244 @ U3,6,7,21
- 1 - 74LS245 @ U8
- 1 - 74LS273 @ U9
- 3 - 74LS374 @ U4,5,15
- 1 - 74LS393 @ U45
  
- 2 - TMM2016 @ U10,16 static RAM
- 1 - 6845SP @ U19
- 1 - 2732 EPROM @ U18



GUIDE 5-1

MULTIFUNCTION CARD:

Provides: RAM memory expansion from 64 K to 256 K (increments of 64 K); clock/calendar (battery backed); one Centronics parallel printer port; two RS232 asynchronous communication ports. With power off, install in any slot. Requires software (one DOS disk) & firmware (two PROMs). Documentation available from supplier.

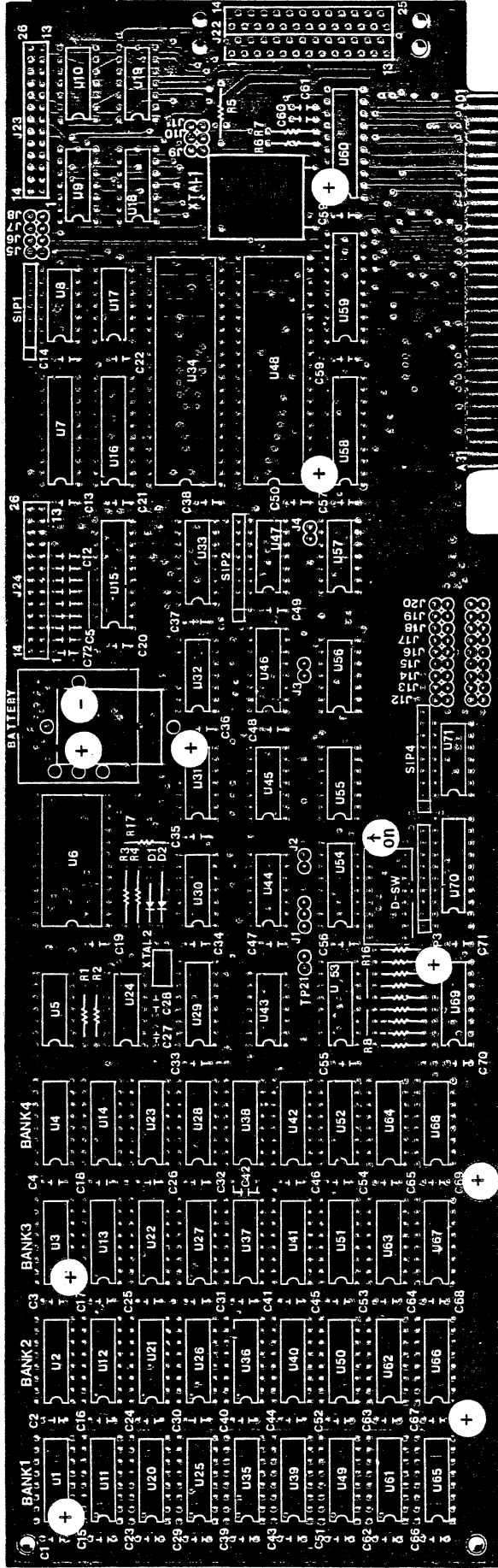

Layout is reduced. Actual size is 33.3 x 11.5 cm.

SUGGESTED SEQUENCE \*INDICATES A PRECAUTION

DIODES \*Position banded end (cathode) RESISTORS (cont)

of diodes as shown

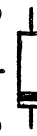
- \_\_\_\_\_ cathode end 
- \_\_\_\_\_ banded end 
- 2 - IN4148



RESISTORS R ¼ watt, 5%

- 9 - 22 Ω @ R8,9,10,11,12,13,14,15,16
- 1 - 220 Ω @ R3
- 1 - 680 Ω @ R5
- 1 - 1.5 KΩ @ R7
- 1 - 2.7 KΩ @ R2
- 1 - 4.7 KΩ @ R1
- 1 - 10 KΩ @ R4
- 1 - 100 KΩ @ R17

CAPACITORS C

- 2 - 18 pF @ C27,28
- 1 - 22 pF @ C60
- 1 - 47 pF @ C61
- 9 - 470 pF @ C5,6,7,8,9,10,11,12,72
- 8 - 4.7 μF/25V Tantalum\* @ C1,3,36, C57,59,67,69,71

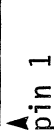
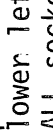
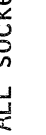
SOCKETS \*Match pin 1 of sockets with pin 1 (square solder pad) on the layout. Check that ALL pins have passed thru ALL holes

- 19 - 14-pin 
- 42 - 16-pin 
- 1 - 18-pin 
- 6 - 20-pin 
- 1 - 24-pin 
- 2 - 40-pin 

\*Match + of Tantalum with + on the layout

SWITCH

- 1 - 8-position DIP @ D-SW

MULTIFUNCTION CARD (cont)

BATTERY

- 1 - 3.6V NiCd, rechargeable @ BATTERY \*Match + & - terminals of battery with + & - on the layout

CRYSTALS Y \*Fold crystals flat against the card before soldering

- 1 - 32.768 KHz @ Y2
- 1 - 1.8432 MHz @ Y1

CONNECTORS

- 1 - DB25 male, 90°, PCB mount @ J22 (serial port #1)
- 2 - 2x13 male header strip, straight, @ J23 (serial port # 2), & @ J24 (parallel port)
- 4 - 1x2 male header strip, straight, @ TP21, J2, 3, 4
- 1 - 1x3 male header strip, straight, @ J1
- 1 - 2x4 male header strip, statight, @ J5, 6, 7, 8
- 1 - 2x3 male header strip, straight, @ J9, 10, 11
- 2 - 2x9 male header strip, straight, @ J12-20
- shorting clips
- 1 - rear panel adapter

INTEGRATED CIRCUITS \*Match pin 1 of ICs with pin 1 (square pad) on the layout

- 1 - 74LS04. @ U32
- 1 - 74LS05 @ U47
- 2 - 74LS08 @ U24, 71
- 2 - 74LS14 @ U43, 44
- 1 - 74LS21 @ U30
- 3 - 74LS32 @ U17, 45, 56
- 1 - 74LS74 @ U55
- 2 - 74LS125 @ U31, 57
- 1 - 74LS138 @ U46
- 1 - 74LS139 @ U29
- 1 - 74LS174 @ U33
- 1 - 74LS240 @ U15
- 3 - 74LS244 @ U7, 58, 59
- 1 - 74LS245 @ U60
- 1 - 74LS280 @ U5
- 1 - 74LS374 @ U16
- 2 - 74S157 @ U53, 69
- 1 - 1488 @ U18
- 2 - 1489 @ U8, 19
- 1 - 58167 @ U6
- 1 - 8250 @ U48
- 1 - 82S129 @ U54 PROM
- 1 - 17S33 @ U70 PROM
- Not equipped @ U9, 10, 34 for serial port #2

4260  
4288  
4140  
4140



**SUPER DISK PLUS I/O CARD:** A general purpose card used to interface the computer to: a) up to four 5 1/4" floppy disk drives, b) one parallel printer, and c) one asynchronous serial device. With power off, install in any available slot. Documentation and schematics are available from the supplier.

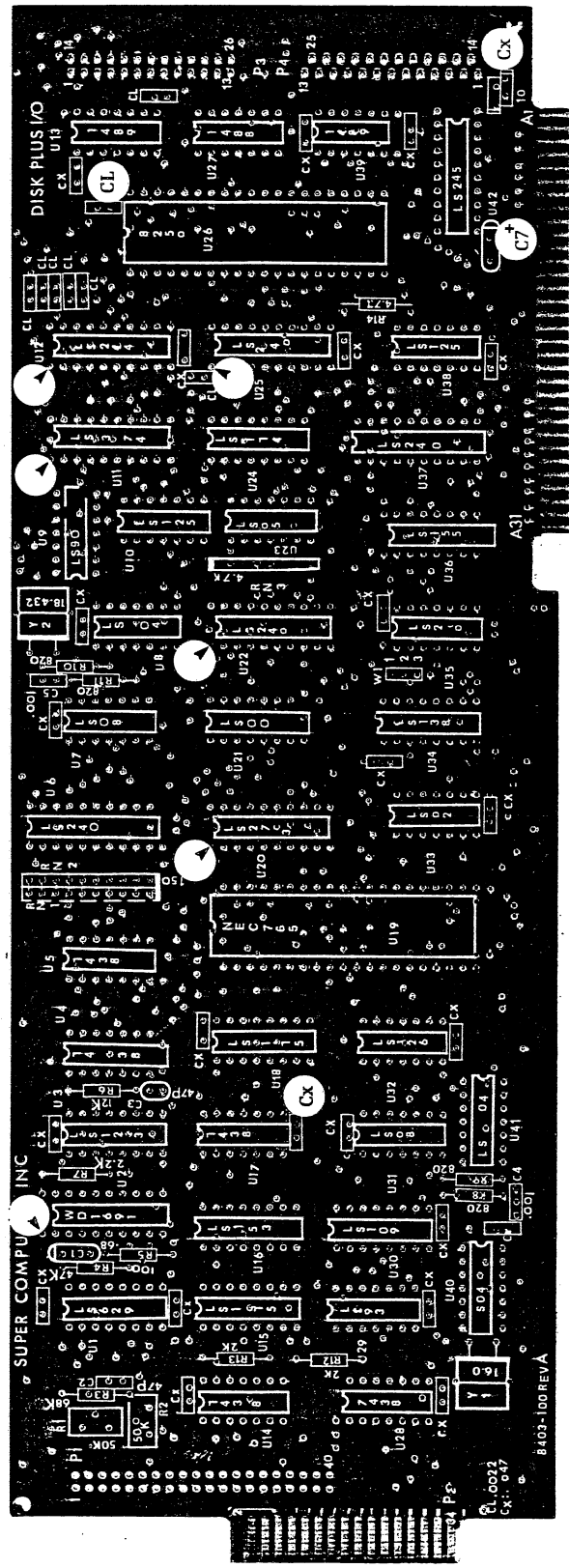

Arrows on the layout indicate pin 1

- SUGGESTED SEQUENCE** \*INDICATES A PRECAUTION
- RESISTORS R 1/4 watt, 5%
    - 1 - 100 Ω @ R5
    - 4 - 820 Ω @ R9,10,11
    - 2 - 2 KΩ @ R12,13
    - 1 - 2.2 KΩ @ R7
    - 1 - 4.7 KΩ @ R14
    - 1 - 12 KΩ @ R6
    - 1 - 47 KΩ @ R4
    - 1 - 68 KΩ @ R3
    - 2 - 50 KΩ Trimpot @ R1,2
  - \*Match pin 1 of the following SIPs with pin 1 (solid line) on the layout
    - 2 - 150 Ω 10-pin SIP @ RN1,2
    - 1 - 4.7 KΩ 8-pin SIP @ RN3
  - SOCKETS \*Match pin 1 of sockets with pin 1 CRYSTALS Y \*Fold crystals flat against the case before soldering. Solder the case to the grounding pads
    - 21 - 14-pin
    - 10 - 16-pin
    - 9 - 20-pin
    - 2 - 40-pin
  - CAPACITORS C
    - 2 - 47 pF @ C2,3
    - 2 - 0.001 μF @ C4,5
    - 8 - 0.0022 μF @ CL
    - 23 - 0.1 μF Monolithic @ Cx
    - 1 - 0.68 μF/25V Tantalum\* @ C1
    - 1 - 10 μF/25V Tantalum\* @ C7
- Layout size is 29.9 x 11.7 cm.

**SUPER DISK PLUS I/O CARD (continued):**

**CONNECTORS**

- 1 - 1x3 header, male, straight @ W (1&2 com 1, 2&3 com 2)
- 1 - 2x20 header, male, straight @ P1 (Drive C & D)
- 1 - 2x13 header, male, straight @ P3 (Parallel port)
- 1 - DB25S 25-pin female, 90° PCB mount, @ P4 (Serial)
- 1 - rear panel adapter
- 1 - jumper plug

**ADJUSTMENT:**

Power up system with drive cables disconnected.  
 Verify that U2 pin 8 is high (3-4V).  
 Adjust R2 trimmer for 1.4V @ U1 pin 2.  
 Adjust R1 trimmer for 4 MHz @ pin 7 of U1 (250 ns)

**INTEGRATED CIRCUITS** \*Match pin 1 of ICs with pin 1 on the layout

- 1 - 74LS00, @ U21
- 1 - 74LS02, @ U33
- 1 - 74LS04, @ U41
- 1 - 74LS05, @ U23
- 2 - 74LS08, @ U7,31
- 1 - 74LS20, @ U35
- 1 - 74LS90, @ U9
- 1 - 74LS93, @ U29
- 1 - 74LS109, @ U30
- 1 - 74LS123, @ U3
- 2 - 74LS125, @ U10,38
- 1 - 74LS126, @ U32
- 1 - 74LS138, @ U34
- 1 - 74LS153, @ U16
- 1 - 74LS155, @ U36
- 1 - 74LS174, @ U24
- 2 - 74LS175, @ U15,18
- 4 - 74LS240, @ U6,22,25,37
- 1 - 74LS244, @ U12
- 1 - 74LS245, @ U42
- 1 - 74LS273, @ U20
- 1 - 74LS374, @ U11
- 1 - 74LS629, @ U1
- 2 - 74S04, @ U8,40
- 5 - 7438, @ U4,5,17,28
- 1 - 1488, @ U27
- 2 - 1489, @ U13,39
- 1 - INS8250, @ U26 (NAT)
- 1 - NEC765, @ U19 (NEC)
- 1 - WD1691, @ U2 (Western Digital)

**PARALLEL PORT:**

Parallel port address is configured as LPT2:(378-37F).  
 To reconfigure as LPT1: (278-27F)  
 i cut trace between pin 10 of U34 and pin 2,14 of U36  
 ii strap pin 14 of U34 to pin 2,14 of U36

**STANDARD IBM DRIVE CABLING:**

i Signals on drives A & C, pins 10 to 16 are swapped at the connector attached to the rear of drive as follows:

- 10 to 16
- 11 to 15
- 12 to 14
- 13 to 13
- 14 to 12
- 15 to 11
- 16 to 10

ii All drives are jumpered for MPX, HL, DS1  
 iii Terminating R-pacs are removed from drives B and D



NuScope Associates

GUIDE 5-3

**MONTE CARLO CARD:** Features: RAM Memory expansion from 64 K to 1 M bytes; one RS-232C Asynchronous Communication Port, programmable from 50 to 9,600 baud; one Centronics parallel printer port; battery-backed clock/calender, with alarm features; two joystick ports. Requires software (one disk) and firmware (one PROM).. Documentation and schematics are available from supplier.

*Check calibration SERIAL PORT*

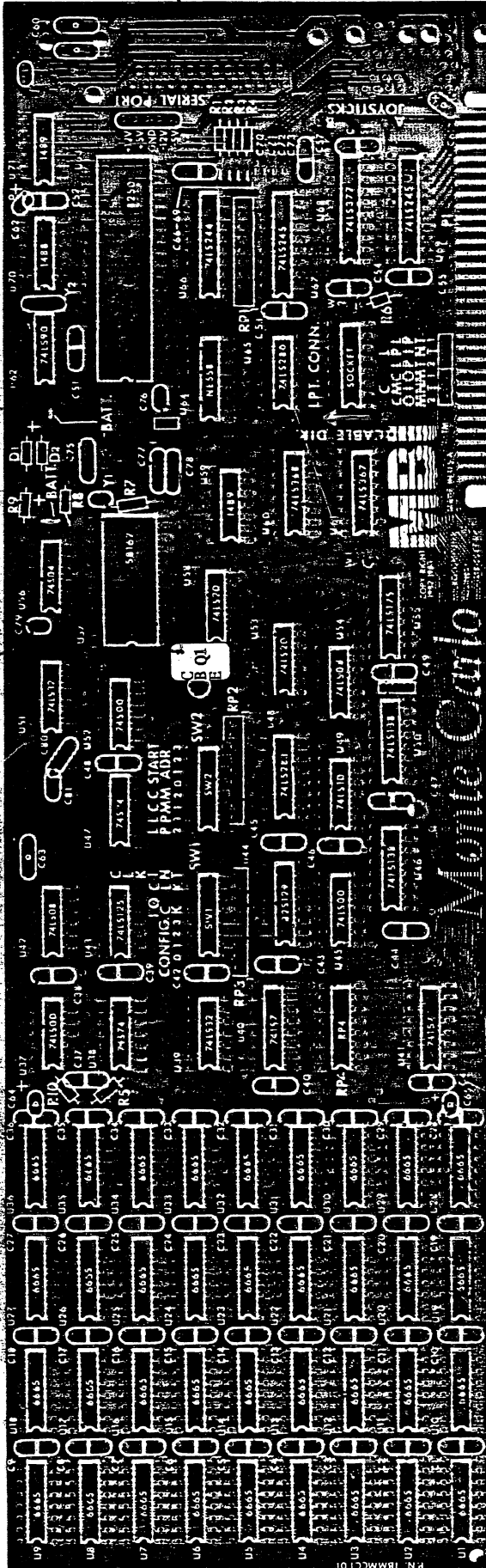

**SUGGESTED SEQUENCE \*INDICATES A PRECAUTION**

**DIODES D** \*Position banded end (cathode) of diode as shown

- 1 - 1N6263 @ D1
- 1 - 1N4454 @ D2

**RESISTORS R** 1/4 watt, 5%

- 2 - 33 Ω @ R5,10
- 2 - 470 Ω @ R8,9
- 1 - 1 KΩ @ R6
- 4 - 2.2 KΩ @ R1,2,3,4
- 1 - 200 KΩ @ R7 \*Install only if using "mini" crystal @ Y1
- 1 - 33 Ω 8-resistor DIP @ RP4 Install in socket. Eight single resistors may be substituted

Layout is reduced. Actual size is 33.5 x 11.8 cm

**RESISTORS (continued)**

- \*Match pin 1 of the following SIP RNS with pin 1 (1) on the layout
- 1 - 1 KΩ 9-pin SIP @ RP1
- 2 - 2 KΩ 9-pin SIP @ RP2,3

**SOCKETS** \*Match pin 1 of sockets with pin 1 on the layout. Check that ALL pins have passed thru ALL holes

- 19 - 14-pin
- 48 - 16-pin
- 4 - 20-pin
- 1 - 24-pin
- 1 - 40-pin

CAPACITORS C

- 1 - 22 pF @ C77
- 4 - 33 pF @ C70,71,72,73
- 2 - 220 pF @ C50,80
- 1 - 0.001 F @ C81
- 13 - 0.01 μF @ C51,52,53,54,55, C56,57,58,66,67, C68,69,76
- 51 - 0.1 μF Monolithic @ C1 to 49, C75,79 @ C59,60,61,62,63, C64,65
- 7 - 10 μF/25V Radial
- 1 - \*Match + with + on layout 5-50 pF Trimcap @ C78

MONTE CARLO CARD (continued)

TRANSISTOR Q \*Match EBC transistor leads with EBC in the layout  
 1 - 2N3904

CRYSTAL Y  
 1 - 32.768 KHz @ Y1\* Install R7 only if using "mini" crystal  
 1 - 18.4320 MHz @ Y2\* Install on solder side. Secure body of crystal to solder side with double-sided tape

SWITCH  
 2 - 8-position DIP

BATTERY  
 1 - 3.0 VDC Hi-Energy Lithium of appropriate size. Match + of battery with + on layout

CONNECTORS  
 1 - 1x6 header, male, straight, below SOCKET, for COM1,2 & LPT 1,2 select  
 1 - 1x5 header, male, straight, near SERIAL PORT, as voltage test pins (not required)  
 1 - DB25P male, 90°, PCB mount @ SERIAL PORT  
 2 - modular telephone jacks, 6-conductor, PCB mount, @ JOYSTICKS A & B  
 1 - 16-pin socket @ SOCKET for parallel port interface

NOT EQUIPPED:

W1  
 W2

3-pin between U30 & C49  
 2-pin between C76 & C77

INTEGRATED CIRCUITS \*Match pin 1 of ICs with pin 1 on the layout

2 - 74LS00 @ U37,45  
 2 - 74LS08 @ U42,54  
 1 - 74LS10 @ U49  
 2 - 74LS20 @ U53,58  
 2 - 74LS32 @ U39,51  
 1 - 74LS90 @ U62  
 1 - 74LS125 @ U43 (74125)  
 2 - 74LS138 @ U46,50  
 1 - 74LS175 @ U55  
 1 - 74LS244 @ U66  
 2 - 74LS245 @ U67,69  
 1 - 74LS280 @ U65  
 1 - 74LS283 @ U48  
 1 - 74LS367 @ U61  
 1 - 74LS368 @ U60  
 1 - 74LS377 @ U68  
 1 - 74S00 @ U52  
 1 - 74S04 @ U56  
 2 - 74S74 @ U38,47  
 1 - 74157 @ U40,41  
 1 - NE558 @ U64  
 1 - 1488 @ U70  
 2 - 1489 @ U59,71  
 1 - MM58167 @ U57 (NAT)  
 1 - 8250 @ U63  
 1 - 82S129 (PROM) @ U44



EK EPROM BURNER & ASYNCHRONOUS SERIAL CARD (two-card set): Consists of (i) RS-232-C serial port - operates from 110 to 9600 baud, and (ii) EPROM programmer that can burn 2716-32-32A-64-128 as well as TMS2508-16-32-64 EPROMs. With power off, install in any vacant slot. Requires software (one disk). Documentation available from supplier.  
 \*Will NOT program 2764A or 27128A.

INTERNAL CARD

Actual size is  
 11.6 x 10.6 cm

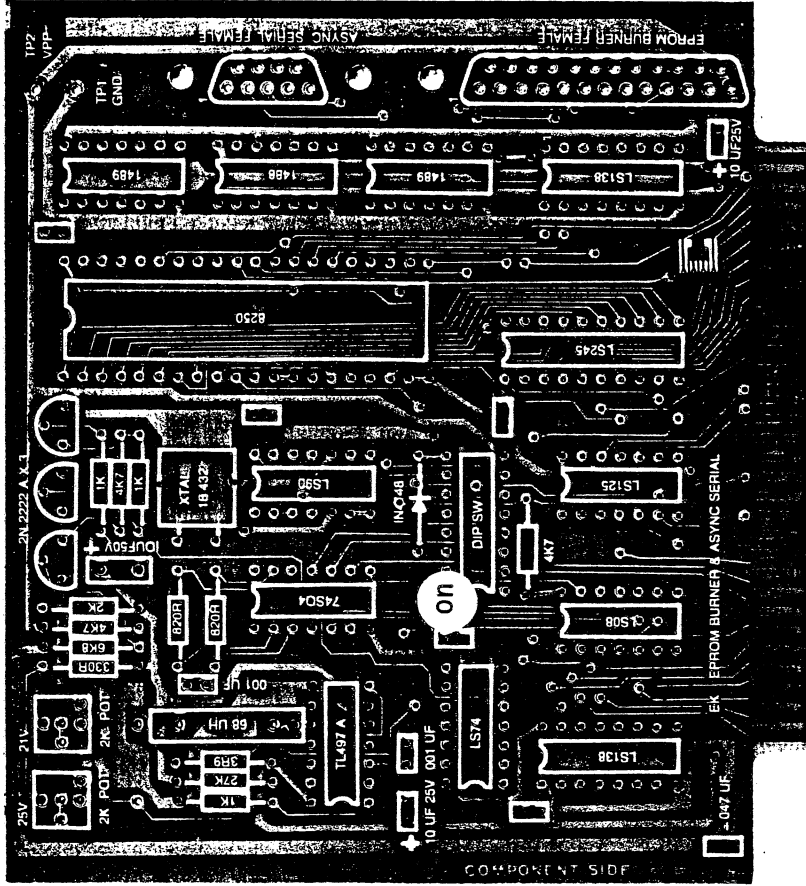

INDUCTOR L

- 1 - 68  $\mu$ H, 1/2 watt

SOCKETS \*Match pin 1 of sockets with pin 1 on the layout. Check that ALL pins have passed thru ALL holes

- 9 - 14-pin
- 2 - 16-pin
- 1 - 20-pin
- 1 - 40-pin

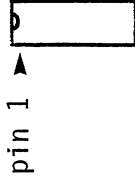

CAPACITORS C

- 2 - 0.001  $\mu$ F
- 5 - 0.047  $\mu$ F (0.1  $\mu$ F) @ Monolithic
- 2 - 10  $\mu$ F/25V Axial\*
- 1 - 10  $\mu$ F/50V Axial\*

TRANSISTORS Q \*Position EBC terminals as shown on the layout



- 3 - 2N2222A

SWITCH

- 1 - 8-position DIP

CRYSTAL Y \*Fold crystal flat against the card before soldering

- 1 - 18.4320 MHz @ XTAL

CONNECTORS

- 1 - DE9S female, 90°, PCB mount
- 1 - DB25S female, 90°, PCB mount
- 2 - header @ TP1,2
- 1 - rear panel adapter

SUGGESTED SEQUENCE \*INDICATES A PRECAUTION

INTERNAL CARD:

- DIODES D \*Position banded (cathode) end of diode as shown
  - 1 - 1N4148 banded end
- RESISTORS R 1/2 watt, 5%
  - 1 - 3.9  $\Omega$
  - 2 - 330  $\Omega$
  - 3 - 820  $\Omega$
- RESISTORS (continued)
  - 1 - 1 K $\Omega$
  - 1 - 2 K $\Omega$
  - 3 - 4.7 K $\Omega$
  - 1 - 6.8 K $\Omega$
  - 1 - 27 K $\Omega$
  - 2 - 2.2 K $\Omega$  trimpot

continued

## EK EPROM BURNER & ASYNCHRONOUS SERIAL CARD (continued)

### INTERNAL CARD (continued)

INTEGRATED CIRCUITS \*Match pin 1 of ICs with pin 1 on the layout

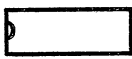
1	74LS08	pin 1	
1	74LS74		
1	74LS90		
1	74LS125		
2	74LS138		
1	74LS245		
1	74S04		
1	1488		
2	1489		
1	TL497A (T.I.)		
1	8250 (NAT)		

### PINOUT FOR DE9S SERIAL CONNECTOR:

pin #	function
1	ring indicator
2	receive data
3	transmit data
4	clear to send
5	request to send
6	data set ready
7	carrier detect
8	signal ground
9	data ready terminal

### INTERNAL CARD SWITCH SETTINGS:

#### I: ASYNCHRONOUS COMMUNICATIONS:

switch	1	2	3	4
com 1	off	on	off	on
com 2	off	on	on	off
aux	on	off	off	on
mic	on	off	on	off

#### II: EXTERNAL EPROM BURNER:

switch	5	6	7	8
+25V VPP	off	on	off	-
+21V VPP	off	off	on	-
pu11 VPP up to +5V	.....	.....	.....	on
pu11 VPP down to ground	...	...	...	off

### CALIBRATION OF EPROM PROGRAMMER VPP VOLTAGES:\*\*

Before using the EPROM burner, adjust the VPP voltages. Select "calibrate" from software menu. Adjust the two trim pots using TP1 GND and TP2 VPP. NB: Lower justify all 24-pin EPROMs in the 28-pin ZIF socket.

\*To program 24-pin 2716 & 2732 jumper 5V; for 28-pin 2764 & 27128 jumper GND

### EXTERNAL CARD:

- SOCKETS**
- 5 - 20-pin
  - 1 - 28-pin ZIF
- CAPACITORS**
- 4 - 0.047  $\mu$ F Monolithic
  - 1 - 10  $\mu$ F/25V Axial\*
- SWITCH**
- 1 - 8-position DIP
- CONNECTORS**
- 1 - DB25P, male, 90°
  - \*Mount on SOLDER side
  - 1 - 1x3 header, male, straight
  - 1 - jumper plug

### INTEGRATED CIRCUITS

- 2 - 74LS244
- 3 - 74LS374

EXTERNAL CARD Actual size is 9.9 x 6.7 cm

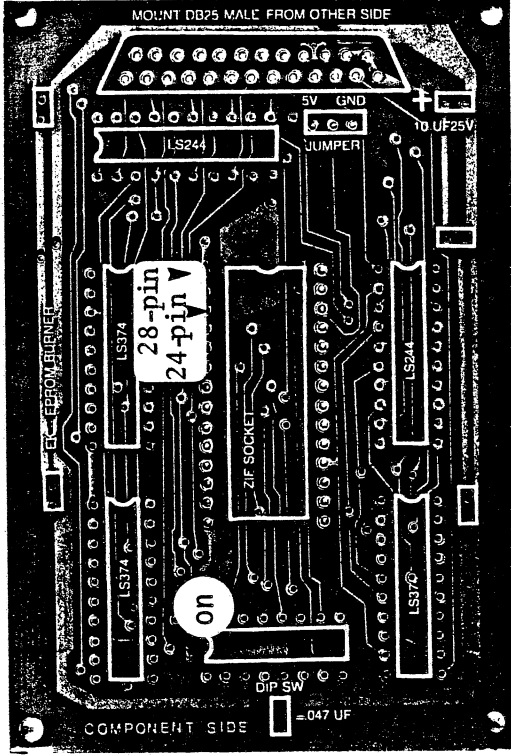

EXTERNAL CARD Actual size is 9.9 x 6.7 cm

MOUNT EXTERNAL CARD with four standoffs on an appropriate base leaving sufficient space for access to DB25 connector. Connect the EXTERNAL CARD to the INTERNAL CARD by means of a ribbon cable of appropriate length.

### SWITCH SETTINGS FOR EPROM BURNER: \*Will NOT program 2764A or 27128A EPROMs

EPROM type	1	2	3	4	5	6	7	8	external card switch settings	internal card switch settings
2716	off	on	off	on	off	off	off	off	on	off
2732	on	off	on	off	off	off	off	off	on	off
2732A	on	off	on	off	off	off	off	off	on	off
2764	on	off	off	off	on	on	off	off	off	on
27128	on	off	off	off	on	on	off	off	off	on
TMS2508	off	on	off	on	off	off	off	off	on	off
TMS2516	off	on	off	on	off	off	off	off	on	off
TMS2532	off	on	off	on	off	off	off	off	on	off
TMS2564	on	off	off	on	off	off	off	off	on	off

\*Check EPROM specifications for chip enable and pull up to +5V or pull down to ground. Set jumper on External card accordingly.



GUIDE 6-2

PARALLEL PRINTER CARD: Allows interface to parallel printers. With power off, install in any free slot. Card will fit in "short slot". Schematics available from supplier.

CONNECTORS  
 1 - DB25S, 25-pin female, 90°, PCB mount, @ J1  
 1 - rear panel adapter

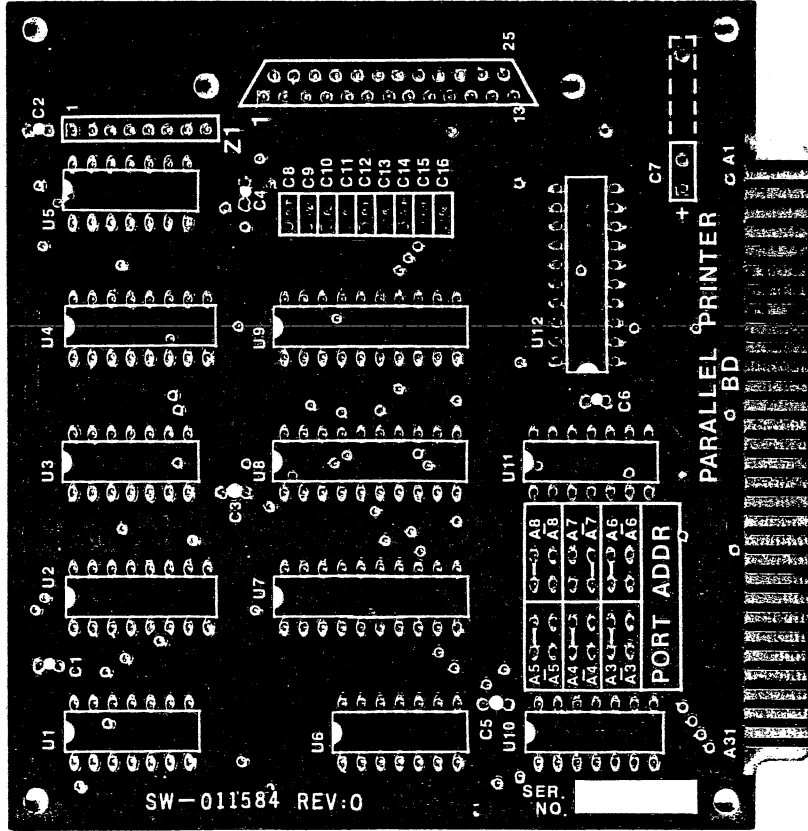

- INTEGRATED CIRCUITS \*Match pin 1 of ICs with pin 1 on the layout
- 2 - 74LS04 @ U6,11
  - 1 - 74LS05 @ U5
  - 1 - 74LS30 @ U10
  - 1 - 74LS32 @ U1
  - 1 - 74LS125 @ U3
  - 1 - 74LS139 @ U2
  - 1 - 74LS174 @ U4
  - 1 - 74LS240 @ U7
  - 1 - 74LS244 @ U8
  - 1 - 74LS245 @ U12
  - 1 - 74LS374 @ U9

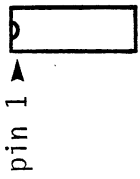

PARALLEL PORT:  
 Parallel port address is configured as LPT2: (378-37F)  
 To reconfigure as LPT1: (278-27F)  
 i cut trace at A8  
 ii strap feed thru holes at A8

Actual size is  
 10.9 x 10.6 cm

- SUGGESTED SEQUENCE \*INDICATES A PRECAUTION
- RESISTORS R 1/4 watt, 5%  
 1 - 4,7 KΩ 8-pin SIP\* @ Z1  
 \*Match pin 1 of SIP with pin 1 on the layout
- CAPACITORS C  
 9 - 0.001 μF @ C8,9,10,11,12,13, C14,15,16  
 6 - 0.1 μF Monolithic @ C1,2,3, C4,5,6  
 1 - 4.7 μF/16V Tantalum\* @ C7  
 \*Match + of Tantalum with + on the layout
- SOCKETS \*Match pin 1 of sockets with pin 1 on the layout. Check that ALL pins have passed thru ALL holes
- 6 - 14-pin
  - 2 - 16-pin
  - 4 - 20-pin



**EM-300 MODEM:** Answer/originate modem operating on a 2-line telephone line at 300 baud in optional half or full duplex. Requires DOS 2.0; 64K RAM memory minimum; 80-column display; software (one disk). With power off and COMPONENT SIDE FACING THE POWER SUPPLY, install in any slot. Documentation available from supplier.

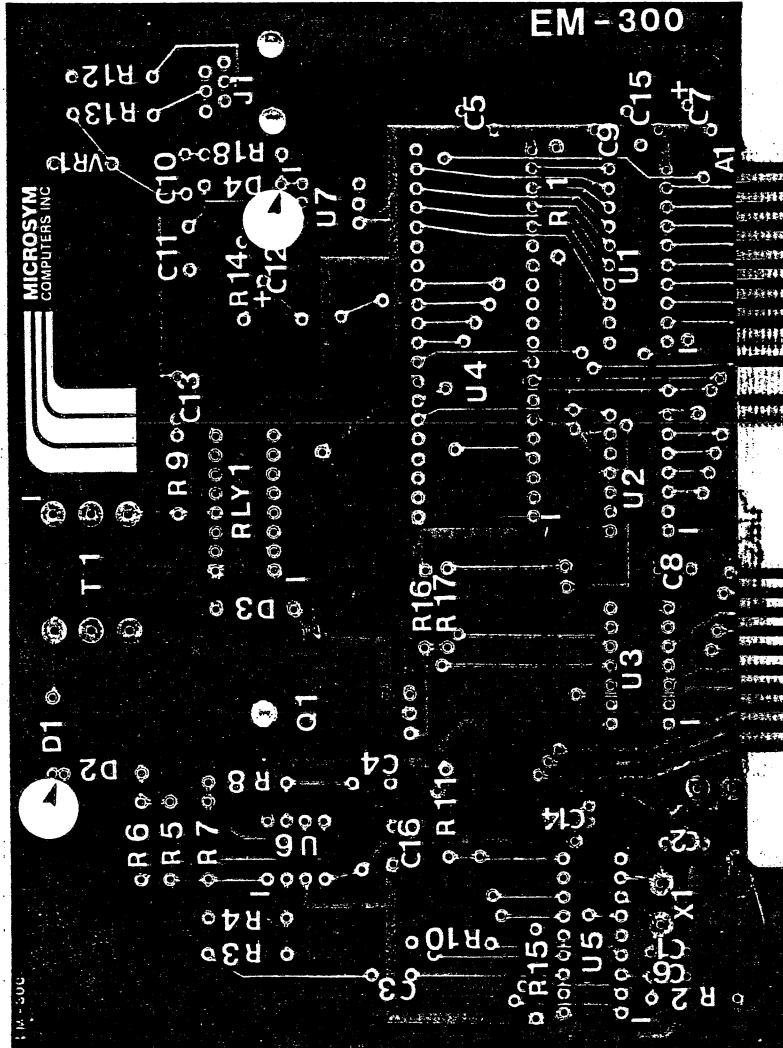

Actual size is  
13.8 x 10.4 cm

**SOCKETS (continued)**

- 1 - 6-pin
- 1 - 8-pin
- 2 - 14-pin
- 1 - 16-pin
- 1 - 18-pin
- 1 - 20-pin
- 1 - 40-pin

**CAPACITORS C**

- 2 - 15 pF @ C1,2
- 1 - 0.001 μF @ C6
- 2 - 0.01 μF @ C14,16
- 9 - 0.1 μF Monolithic @ C3,4,5, C8,9,10,11,13,15

\*Match + of the following with + on layout

- 1 - 2.2 μF/35V Tantalum\* @ C7
- 1 - 4.7 μF/35V Tantalum\* @ C12

**TRANSISTOR Q** \*Position metal part of device flat against the card before soldering

- 1 - TIP125 or TIP127 @ Q1

**CRYSTAL Y** \*Fold crystal flat against the card before soldering

- 1 - 4.032000 MHz @ X1

**VARIATOR**

- 1 - V120ZA1 (GE) @ VR1

**RELAY**

- 1 - G2V-2 5V (Omron) @ RLY 1

**TRANSFORMER**

- 1 - 141H (Hammond) 600CT/600CT
- Line matching @ T1

**CONNECTORS**

- 1 - modular telephone jack, PCB 6-pin, PCB mount, @ J1

**SUGGESTED SEQUENCE** \*INDICATES A PRECAUTION

**DIODES D** \*Position banded end (cathode) towards the arrow on the layout

- 2 - 1N751A @ D1,2
- 1 - 1N4148 @ D3
- 1 - 1N4001 @ D4
- RESISTORS R 1/4 watt, 5%
- 2 - 1 Ω @ R12,13
- 1 - 560 Ω @ R5
- 1 - 1 KΩ @ R1
- 1 - 2.2 KΩ @ R17
- 1 - 2.2 KΩ 1/2 watt\* @ R18
- 1 - 4.7 KΩ @ R9
- 1 - 6.8 KΩ @ R4
- 8 - 10 KΩ @ R3,6,7,8,10,11,14,15
- 1 - 22 KΩ @ R16
- 1 - 4.7 MΩ @ R2

**SOCKETS** \*Match pin 1 of sockets with pin 1 (1) on the layout. Check that ALL pins have passed thru ALL holes

EM-300 MODEM (continued):

INTEGRATED CIRCUITS \*Match pin 1 of ICs  
with pin 1 on the layout

1 - 74LS14 @ U3

1 - 74LS30 @ U2

1 - 74LS245 @ U1

1 - 4N32 @ U7

1 - MC1458 @ U6

1 - TMS99532 (T.I.) @ U5 Modem IC

1 - 2681A (SIG.) @ U4 DUART 40-pin

GUIDE 7-1

**DATA MAX-001:** Allows user to design prototype hardware. Approximately 4600 holes (10 holes per inch on 0.1 inch centres) for wire-wrap or solder-tail sockets. Two bus lines, one connected to ground, are present on each side.

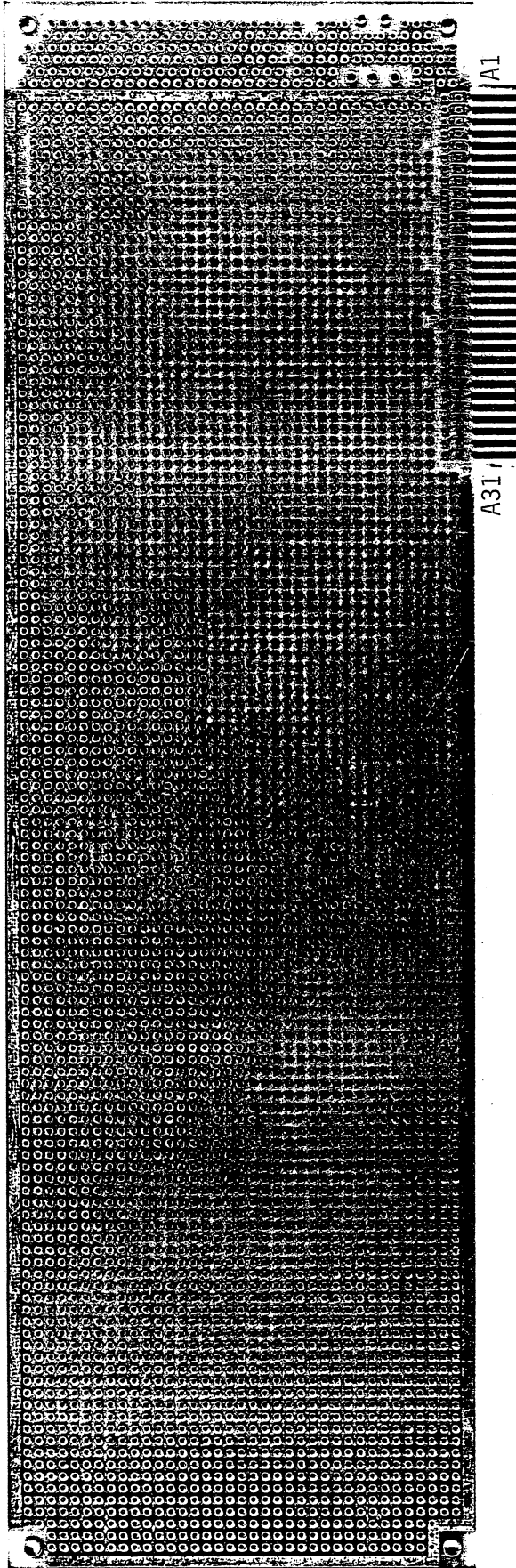

SIDE B		A SIDE	
GND	1	1	I/OCHK
RESET	2	2	D7
+5V	3	3	D6
IRQ2	4	4	D5
-5V	5	5	D4
DRQ2	6	6	D3
-12V	7	7	D2
NC	8	8	D1
+12V	9	9	D0
GND	10	10	I/OCHRDY
MEMW	11	11	AEN
MEMR	12	12	A19
TOW	13	13	A18
TOR	14	14	A17
DACK3	15	15	A16
DRQ3	16	16	A15
DACK1	17	17	A14
DRQ1	18	18	A13
DACK0	19	19	A12
CLK	20	20	A11
IRQ7	21	21	A10
IRQ6	22	22	A9
IRQ5	23	23	A8
IRQ4	24	24	A7
IRQ3	25	25	A6
DACK2	26	26	A5
T/C	27	27	A4
ALE	28	28	A3
+5V	29	29	A2
OSC	30	30	A1
GND	31	31	A0



GUIDE 7-2

MEMORY PROTOTYPE CARD:

Prototype card with 256 K or 1 M bytes of memory layout using 4164 or 256 K RAM chips, respectively. Extensive wire-wrap area - approximately 2700 holes, 10 holes per inch, on 0.1 inch centres. DE9 and DB25 footprints are present on card for I/O.

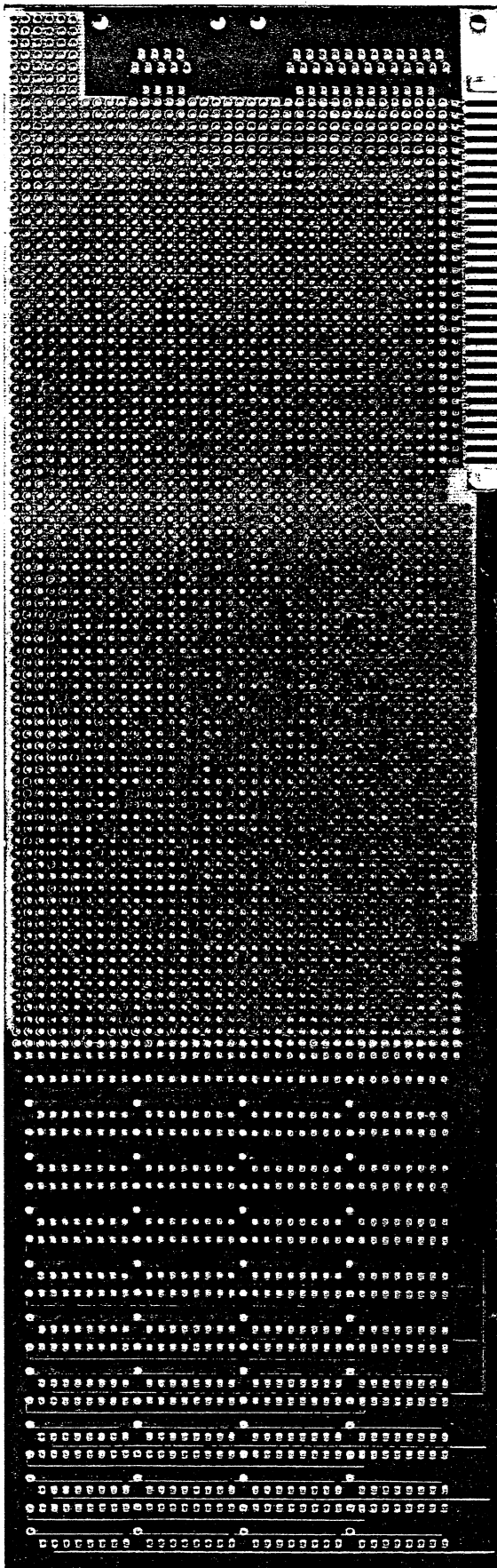

A1

A31

SIDE B		A SIDE	
GND	1	1	I/OCHK
RESET	2	2	D7
+5V	3	3	D6
IRQ2	4	4	D5
-5V	5	5	D4
DRQ2	6	6	D3
-12V	7	7	D2
NC	8	8	D1
+12V	9	9	D0
GND	10	10	I/OCHRDY
MEMW	11	11	AEN
MEMR	12	12	A19
TOW	13	13	A18
IOR	14	14	A17
DACK3	15	15	A16
DRQ3	16	16	A15
DACK1	17	17	A14
DRQ1	18	18	A13
DACK0	19	19	A12
CLK	20	20	A11
IRQ7	21	21	A10
IRQ6	22	22	A9
IRQ5	23	23	A8
IRQ4	24	24	A7
IRQ3	25	25	A6
DACK2	26	26	A5
T/C	27	27	A4
ALE	28	28	A3
+5V	29	29	A2
OSC	30	30	A1
GND	31	31	A0

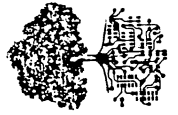

NuScope Associates

GUIDE 7-3

PROTOPLUS PROTOTYPE CARD: Allows user to design prototype hardware. Completely covered with holes (approximately 4800 holes, 10 holes per inch, 0.1 inch spacing) for wire-wrap and solder-tail sockets.

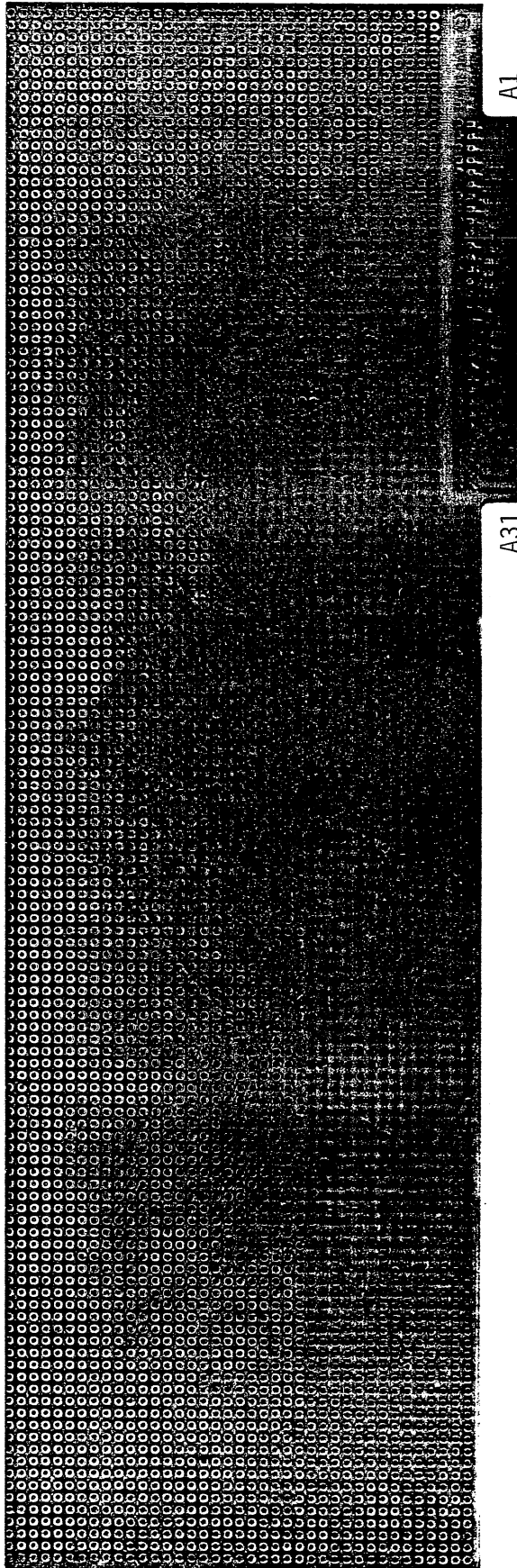

SIDE B		A SIDE	
GND	1	1	<u>I/OCHK</u>
RESET	2	2	D7
+5V	3	3	D6
IRQ2	4	4	D5
-5V	5	5	D4
DRQ2	6	6	D3
-12V	7	7	D2
NC	8	8	D1
+12V	9	9	D0
GND	10	10	<u>I/OCHRDY</u>
<u>MEMW</u>	11	11	AEN
<u>MEMR</u>	12	12	A19
<u>IOW</u>	13	13	A18
<u>IOR</u>	14	14	A17
<u>DACK3</u>	15	15	A16
<u>DRQ3</u>	16	16	A15
<u>DACK1</u>	17	17	A14
<u>DRQ1</u>	18	18	A13
<u>DACK0</u>	19	19	A12
CLK	20	20	A11
IRQ7	21	21	A10
IRQ6	22	22	A9
IRQ5	23	23	A8
IRQ4	24	24	A7
IRQ3	25	25	A6
<u>DACK2</u>	26	26	A5
T/C	27	27	A4
ALE	28	28	A3
+5V	29	29	A2
OSC	30	30	A1
GND	31	31	A0





SOLDER CARD EDGE CONNECTOR  
TO  
TOP OF BOARD

**EXTENDER BOARD:** Lifts card 15 cm above the motherboard for easy testing and servicing.

Secure a 62-pin card edge connector to the top of the EXTENDER BOARD so that the pins of the connector line up with the traces on the BOARD. Centre the connector and solder the end pins to the BOARD. Check that the pins are lined up and solder the remaining pins to the BOARD. Appropriately label one end of the connector "A1" and "B1".

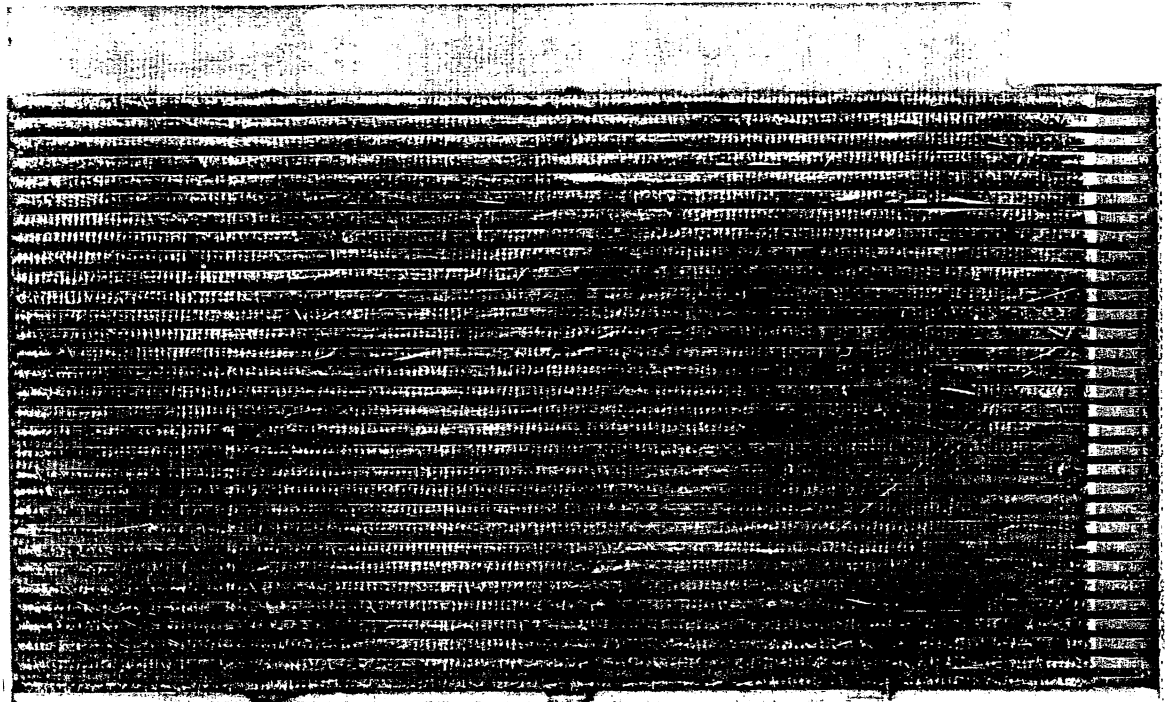

CONNECT TO MOTHERBOARD

gold fingers

SIDE B	A SIDE
GND	1
RESET	2
+5V	3
IR02	4
-5V	5
DR02	6
-12V	7
NC	8
+12V	9
GND	10
RENR	11
RENR	12
TRM	13
TRM	14
DACK1	15
DR03	16
DACK1	17
DR01	18
DACK0	19
CLK	20
TR07	21
TR06	22
TR05	23
TR04	24
TR03	25
DACK2	26
T/C	27
ALE	28
+5V	29
OSC	30
GND	31
	A0
	A1
	A2
	A3
	A4
	A5
	A6
	A7
	A8
	A9
	A10
	A11
	A12
	A13
	A14
	A15
	A16
	A17
	A18
	A19
	AEN
	L/OCHRDY
	D0
	D1
	D2
	D3
	D4
	D5
	D6
	D7
	L/OCHK

